

UltraLyte

User's Manual



For Internal Use Only. Not for Distribution.



LIMITED WARRANTY

For Internal Use Only. Not for Distribution.

Laser Technology, Inc. (LTI) warrants the UltraLyte to be in good working order for a period of one year from the date of purchase from LTI or an authorized LTI product dealer. Should the product fail to be in good working order at any time during the warranty period, LTI will, at its option, repair or replace the product at no additional charge, except as set forth below. Repair parts and replacement parts and products become the property of LTI. This limited warranty does not include service or repair of damage to the product resulting from accident, disaster, misuse, abuse, or non-LTI modification of the product.

To activate your warranty, return the warranty card from the front of this manual to LTI within 30 days of purchase. To obtain limited warranty service, deliver the product during the one-year period to Laser Technology's Service Center and provide proof of the purchase date. If the product is delivered by mail, you agree to insure the product or assume the risk of loss or damage in transit, and to prepay the shipping container or equivalent.

LTI hereby disclaims all other express and implied warranties for the product, including warranties of merchantability and fitness for a particular purpose. (Some states do not allow the exclusion of implied warranties, so the above limitation may not apply to you.)

LIMITED WARRANTY

For Internal Use Only. Not for Distribution.

If the product is not in good working order as warranted above, your sole remedy shall be repair or replacement as provided above. In no event will LTI be liable to you for any damages, including any lost profits, lost savings, or other incidental or consequential damages arising from the use or inability to use such product. Furthermore, LTI shall not be held responsible if any LTI authorized dealer has been advised of the possibility to such damages, or for any claim by any other party.

Note: The Warranty Validation Card (at the front of this manual) must be completed and activated in order to benefit from this warranty. **No exceptions.**

In the unlikely event that your new LTI laser should require warranty or repair service, call us to receive a Return Merchandise Authorization (RMA) number before returning your product. Contact us at:

Laser Technology
7070 South Tucson Way
Englewood, CO 80112 USA
Phone: 303-649-1000
Web Site: www.lasertech.com

About This Manual

This manual describes the options, characteristics, and operation of the Laser Technology, Inc. UltraLyte and UltraLyte LR laser speed and ranging instruments.

The UltraLyte has a large number of options and is highly configurable. This manual describes all the possible options. Your particular UltraLyte instrument may not have all the options described.

The UltraLyte LR (“long range”) functions identically to a standard UltraLyte, but provides longer ranging capability to non-cooperative targets.

Laser Technology, Inc.
7070 South Tucson Way
Englewood, CO 80112 USA
Phone: 303-649-1000
Fax: 303-649-9710

PRECAUTIONS

Avoid staring directly at the laser beam for prolonged periods.



The UltraLyte is designed to meet FDA eye safety requirements and is classified as eye-safe to Class 1 limits, which means that virtually no hazard is associated with directly viewing the laser output under normal conditions. As with any laser device, however, reasonable precautions should be taken in its operation. It is recommended that you avoid staring into the transmit aperture while firing the laser. The use of optical instruments with this product may increase eye hazard.

Never attempt to view the sun through the scope.

Looking at sun through the scope may permanently damage your eyes.

Never point the instrument directly at the sun.

Exposing the lens system to direct sunlight, even for a brief period, may permanently damage the laser transmitter.

Do not expose the instrument to extreme temperatures.

UltraLyte components are rated for a temperature range of -30° C (-22° F) to +60° C (+140° F). Do not expose the instrument to temperatures outside that range.

Laser Technology UltraLyte Quick Reference

Legend:

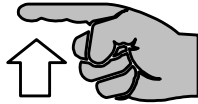

Press and release

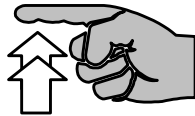

Press and release repeatedly

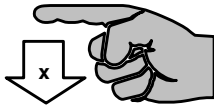

Press and hold "x" seconds

Power On/Off

Power On

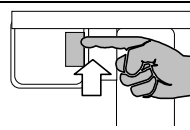

Power Off

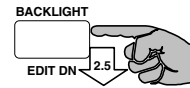

Speed Measurement

Basic speed measurement

SPEED

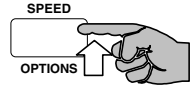

Time Over Distance

SPEED TOD

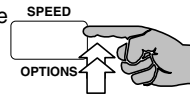

UL100 Distance Measurement

Slope distance

SURVEY

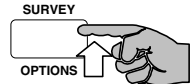

UL200 Distance Measurement

Horizontal distance

SURVEY



Slope distance

SURVEY

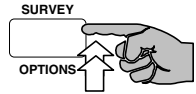

Vertical distance

SURVEY



Inclination angle

SURVEY



Display Backlight

Backlight on

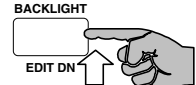

Backlight off

EDIT DN

Option Menu

Scope brightness
MENU br

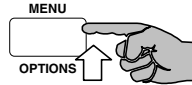

Range gate - short
MENU GS

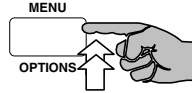

Range gate - long
MENU G L

Download format
MENU
20.20.Cr
UL100/UL200

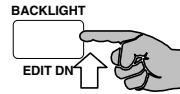

Continuous mode
MENU CONT

Mute
MENU MUTE

Power conservation
MENU ALL On

(To select an option value or to turn an option on or off)

Test Functions

Display test

(All display segments on)

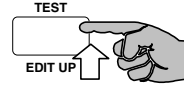

Aim test tone
TEST tt

Battery voltage
TEST BATT

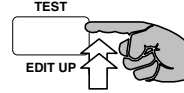

Delta distance test
TEST DELTA

Edit Mode

Start

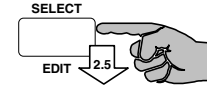

Select next digit
Leave edit mode

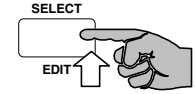

Add 1 to the current digit

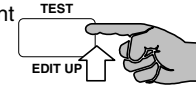

Subtract 1 from the current digit

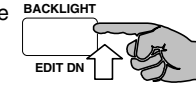

Auto repeat

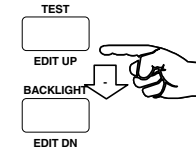

TABLE OF CONTENTS

For Internal Use Only. Not for Distribution.

LIMITED WARRANTY

PRECAUTIONS

CHECKING THE INSTRUMENT 1

Basic UltraLyte Package 1

Accessories 1

ANATOMY OF THE ULTRALYTE 2

Models 2

Features 2

Sensors 3

The LCD Screen 4

Serial Port Connector 4

Sighting Scope 5

Button Panels 6

INSERTING THE BATTERIES 7

USING THE STOCK 8

Unfolding the Stock/Left-handed Operation... 8

Unfolding the Stock for Right-handed Operation

..... 9

Adjusting the Length and Angle 10

Refolding the Stock 10

ATTACHING THE YOKE 11

POWERING ON AND OFF 12

Testing the Display 12

Checking the Model Number 12

Restoring the Default Configuration 13

SCREEN INDICATORS 14

MENU OPTIONS 17

LISTENING TO THE INSTRUMENT 18

EDIT MODE 19

BASIC SPEED MEASUREMENT 20

Measuring a Moving Vehicle 21

The JAM Indicator 21

Line of Sight 22

The Cosine Effect 22

TIME-OVER-DISTANCE MEASUREMENT .. 25

Entering the Distance Manually 26

Measuring the Distance 27

Taking the Measurements 29

Notes on Using TOD 30

TABLE OF CONTENTS

For Internal Use Only. Not for Distribution.

SURVEY MEASUREMENTS.....	31	SETTING DOWNLOAD FORMATS.....	44
Taking the Measurement	31	TESTING DISPLAY INTEGRITY.....	45
In-scope Display.....	32	SCOPE ALIGNMENT TEST	46
Grouping Sensors on a UL200	33	BATTERY VOLTAGE DETECTION.....	47
ERROR CONDITIONS.....	34	INSTRUMENT CONFIDENCE CHECK.....	48
Error Codes.....	35	Fixed Distance Check	49
RFI Considerations	35	Delta Distance Check.....	49
IN-SCOPE DISPLAY INTENSITY	36	MAINTENANCE.....	52
GATES AND GATE WINDOWS	37	Operating Temperature.....	52
Gate Window Characteristics.....	37	Moisture and Dust Protection.....	52
Setting a Gate Value.....	38	Shock Protection	52
Turning Off a Gate	39	Cleaning and Storage	52
MEASUREMENT UNITS.....	40	Caring for the Scope	52
Notes.....	40	Checking the Display Screen	53
CONTINUOUS MODE	41	Resetting Factory Option Defaults	53
MUTING THE INSTRUMENT.....	42		
POWER CONSERVATION INTERVALS	43		

TABLE OF CONTENTS

For Internal Use Only. Not for Distribution.

REALIGNING THE SCOPE	54
Target Selection	54
Adjustment Screws	55
Realignment Procedure	56
Aligning the Tilt Sensor	57
SPECIFICATIONS	58
APPENDIX A.....	59
SERIAL INTERFACE SPECIFICATIONS	
.....	61
Data Formats	61
Format Parameters	62
UltraLyte Download Format	62
<i>Version Queries</i>	62
<i>Speed/Range Data Message Format</i>	63
<i>Survey Data Message Format</i>	64
Criterion Download Format	65
<i>Version ID Requests</i>	65
<i>Survey Data Message Format</i>	66
20-20 Download Format	68
<i>Version ID Requests</i>	68
<i>Speed/Range Data Message Format</i>	70

CHECKING THE INSTRUMENT

For Internal Use Only. Not for Distribution.

Checking the Instrument

When you receive your UltraLyte laser instrument, check to see that you have received everything you ordered. If you perceive any physical damage to the instrument, or if any ordered part is missing, contact the shipper.

Basic UltraLyte Package

- UltraLyte instrument
- Two C batteries
- User's manual
- Padded carrying case

Accessories

In addition, you may have ordered one or more of these optional accessories:

- Yoke with adapter for tripod mounting
- Two UltraLyte download cables:
 - Turck 4-pin to DB 9-pin cable
 - Turck 4-pin to HP 200/48 10-pin cable
- Data collector and software

ANATOMY OF THE ULTRALYTE

For Internal Use Only. Not for Distribution.

Anatomy of the UltraLyte

The Laser Technology, Inc. UltraLyte is a hand-held laser speed detection and ranging device. It measures and displays the speed of a moving vehicle and the range at which the speed was measured. The instrument may also be used to make basic survey measurements.

Models

There are two UltraLyte models: the UL100 and the UL200.

The UL100 is a basic instrument that measures the speeds of moving vehicles and simple distances to target objects.

The UL200, in addition to measuring speed and range, has a tilt sensor that measures inclination angles. The tilt sensor allows the instrument to compute horizontal distance measurements for more complex survey tasks such as accident reconstruction.

Features

- Sighting scope with in-scope aiming dot and measurement display
- Powered by two C batteries conveniently tucked away in the handle
- Fully adjustable, fold-away shoulder stock
- Two 3-button operator panels for quick and easy access to instrument functions
- Serial output port for easy connection to a data collector or notebook computer
- Liquid Crystal Display (LCD) screen for instant access to measurements and options

ANATOMY OF THE ULTRALYTE

For Internal Use Only. Not for Distribution.

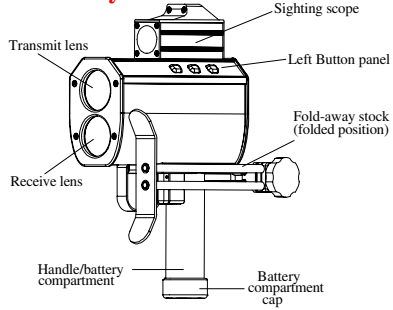

Front / Left Side

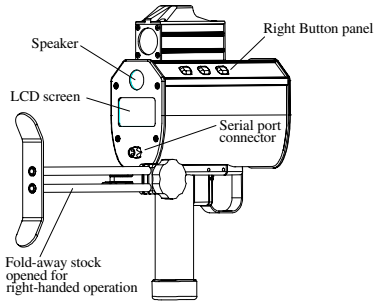

Rear / Right Side

Sensors

The UltraLyte has two lenses on the front panel. The top lens transmits infrared laser signals; the bottom lens receives signals back from the target and feeds signal information to the internal circuitry.

The internal circuitry consists of a laser range sensor, a tilt sensor (Model 200 only), and timing, analysis, computation, and display circuits.

The UltraLyte determines distance through its laser range sensor, by measuring the time of flight of short pulses of infrared light. The UltraLyte has a broad spectrum of sensitivity, and can work with both reflective and nonreflective targets.

The maximum measurement distance varies with target and environmental conditions. The

ANATOMY OF THE ULTRALYTE

For Internal Use Only. Not for Distribution.

absolute maximum is about 2000 feet (610 meters) for an UltraLyte, and 4000 feet (1200 meters for an UltraLyte LR.

The tilt sensor on the Model 200 measures vertical angles, which the instrument uses to calculate height and elevation. The tilt sensor can take full 360-degree angular measurements, displaying them as ± 180 degrees. (When held level, the instrument is at 0 degrees. It is rotated up through +180 degrees, and down through -180 degrees.)

The LCD Screen

The LCD screen displays measurements and option indicators. When the instrument is powered on, for example, the speed measurement screen displays:

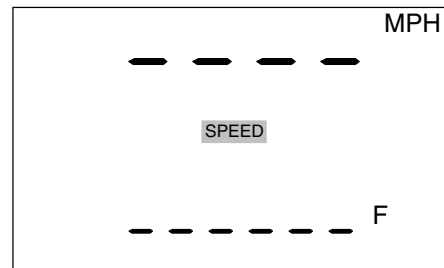

The indicator “SPEED” means the instrument is in speed mode and is prepared to take a speed and range measurement.

Dashes indicate where the two measurements will appear: speed at the top of the screen, range at the bottom. “MPH” means the speed will be measured in miles per hour. (“KmH” means kilometers per hour; “CmS” means centimeters per second.) “F” means the range will be measured in feet. (“M” indicates meters.)

ANATOMY OF THE ULTRALYTE

For Internal Use Only. Not for Distribution.

Serial Port Connector

The serial port connector allows you to connect the instrument to a data collector or notebook computer. The UltraLyte can download speed and range data in its own format, or in the same format as earlier Laser Technology speed detection instruments for compatibility with existing software.

Sighting Scope

Mounted atop the UltraLyte is a single-power sighting scope. The scope features:

- an adjustable polarizing light filter to optimize viewing contrast
- an in-scope, red aiming dot to help you aim accurately to the target
- an in-scope measurement display

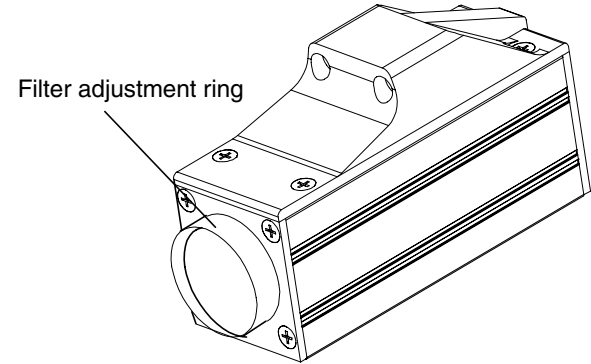

Scope Exterior

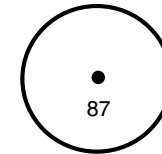







In-scope Display

BUTTON PANELS

For Internal Use Only. Not for Distribution.

Button Panels

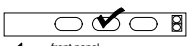
The UltraLyte has two 3-button panels, one on each side of the instrument. The buttons give you access to instrument functions. The buttons have the following functions:

Panel	Button Location	Button Name	Purpose
Right		Menu/Options	Activates the instrument's function menu. Selects menu options.
		Survey/Options	Activates the instrument's survey measurement mode. Selects specific survey measurement options.
		Speed/Options	Activates the instrument's speed measurement mode. Selects specific speed measurement options.
Left		Select/Edit	Selects option values in the function menu. Activates edit mode, in which values can be entered manually. With edit mode active, selects a digit to be edited.
		Test/Edit Up	Activates the instrument's test mode. In edit mode, adds 1 to the currently selected digit.
		Backlight/Edit Down	Press and release: Turns the display backlight on or off. Press and hold for 2.5 seconds: Turns the instrument off. In edit mode, subtracts 1 from the currently selected digit.

INSERTING THE BATTERIES

For Internal Use Only. Not for Distribution.

Inserting the Batteries

Load two C batteries by inserting them positive-end-first into the battery compartment in the instrument handle.

Warning: The UltraLyte is designed to accept normal C cells. NiCad batteries can be used, but they tend to vary in size. Laser Technology will not be responsible for damage that results from trying to force NiCad cells in or out of the battery compartment.

To close the battery compartment, replace the cap and twist it until it stops. **DO NOT OVERTIGHTEN.**

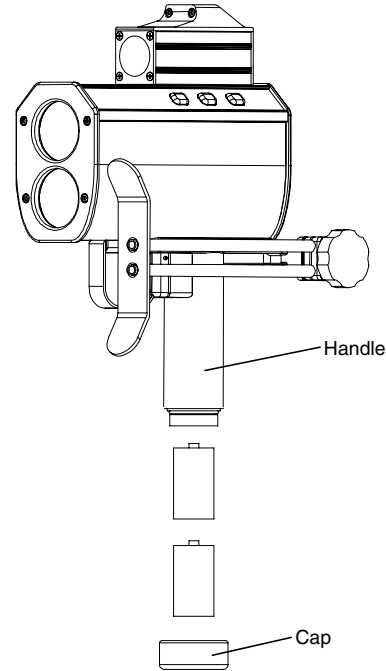

USING THE STOCK

For Internal Use Only. Not for Distribution.

Using the Stock

Unfolding the Stock for Left-handed Operation

To open the stock for left-handed operation:

1. Loosen the stock by turning the tension knob counter-clockwise.
2. Rotate the stock 180 degrees.
3. Retighten the tension knob.

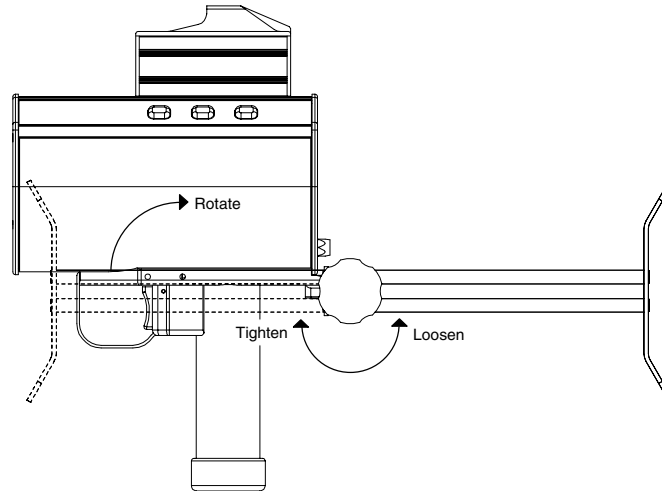

USING THE STOCK

For Internal Use Only. Not for Distribution.

Unfolding the Stock for Right-handed Operation

To unfold the stock for right-handed operation:

1. Hold the instrument firmly and press down on the retaining plate with sufficient force to disengage the plate from the stock's retainer peg.
2. Pull the stock away from the body of the instrument and release the plate.
3. Swivel the stock to the right until the retainer peg re-engages. When the peg engages, you hear a loud click.

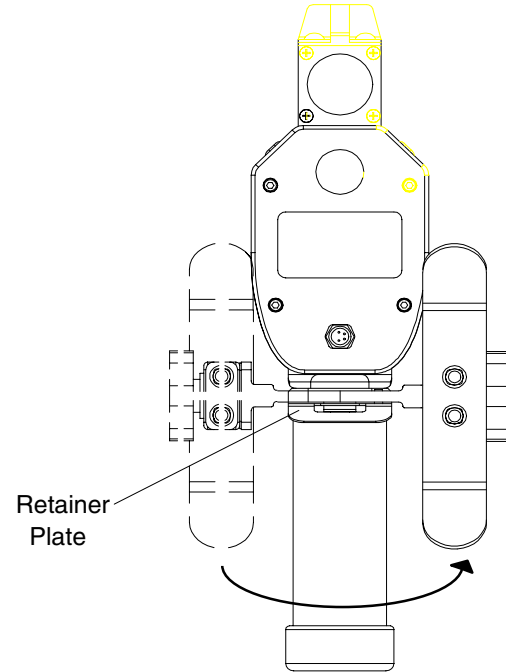

USING THE STOCK

For Internal Use Only. Not for Distribution.

Adjusting the Length and Angle

To adjust the length of the stock, loosen the tension knob and slide the stock back and forth.

To adjust the stock angle, loosen the tension knob slightly and move the stock up or down. Usually it is best if the stock is at a slight downward angle.

Refolding the Stock

To refold the stock, extend it to its full length and reverse the procedure you used to open it. Note that though the stock can be folded on either side, the instrument fits in its case only when the stock is fully extended and folded on the left side of the instrument.

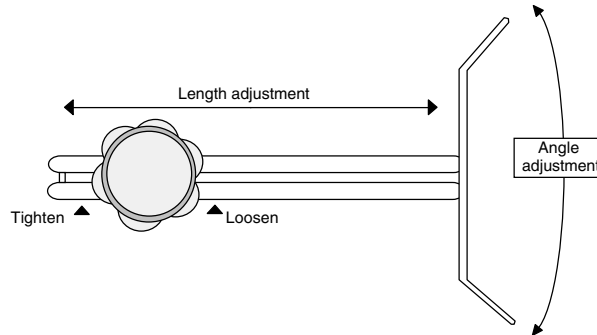

ATTACHING THE YOKE

For Internal Use Only. Not for Distribution.

Attaching the Yoke

The UltraLyte includes, as an option, a “yoke” that allows you to mount the instrument on a tripod or monopod. In order to attach the yoke, you must first assemble a “yoke adapter” to the instrument.

To attach the yoke adapter, screw the mounting bracket and adapter into the mounting holes on the side of the instrument base. Fit the yoke onto the mounting bracket and tighten the knob.

The yoke can be mounted on either side of the instrument. When the yoke is mounted on the left side of the instrument, the entire assembly fits into the UltraLyte padded carrying case.

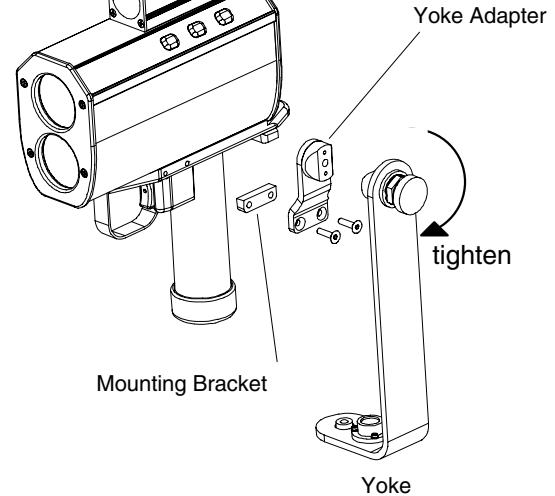

POWERING ON AND OFF

For Internal Use Only. Not for Distribution.

Powering On and Off

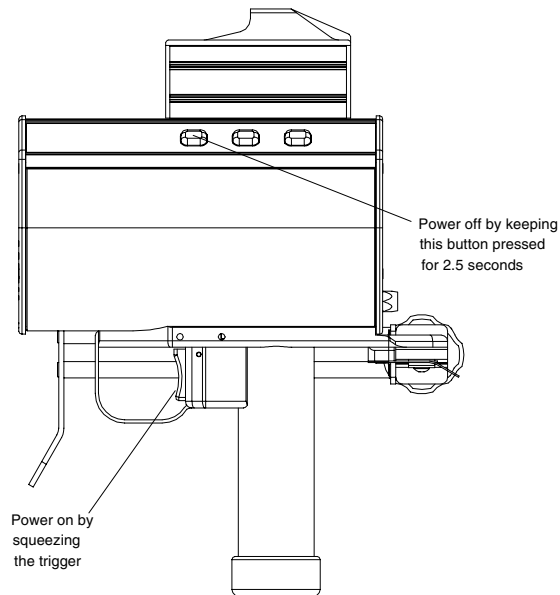

Power the instrument on by simply pressing the trigger. Power off by pressing the Backlight/Edit Dn button and keeping it pressed for about 2.5 seconds. See the illustration at left.

The instrument includes three simple functions you can perform at power-on time. Those functions are:

- Testing the display
- Checking the model number and units
- Restoring factory default configuration

Testing the Display

When you power-on the instrument, you can test the screen display by holding down the trigger instead of releasing it. That shows all the display segments so you can check that they are all operating.

For more information, see "[Testing Display Integrity](#)," later in this manual.

POWERING ON AND OFF

For Internal Use Only. Not for Distribution.

Checking the Model Number

You can also check the instrument's model number and software revision level when you power-on. Start as you would if you were checking the display: press the trigger and keep it pressed. With the display segments all showing, press and hold the Speed/Options button as you continue to hold down the trigger.

That causes the screen to switch to a display that looks something like this (for example):

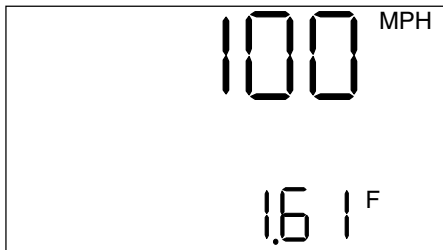

The number at the top is the model number of the instrument. The number at the bottom is the revision level of the instrument's internal software. MPH and F indicate the factory default speed and range units in effect at the time the instrument was shipped.

Restoring the Default Configuration

When the instrument was shipped, options such as the units and the brightness of the in-scope display were already set for you. Those settings constitute the *factory default configuration*. If you find yourself unsure of the instrument's configuration, you can restore the factory default and start fresh with known option settings.

To do that, power off. Then power back on and keep the trigger pressed. While still holding down the trigger, press and hold Backlight/Edit Dn until the message **CLEAR** appears on the display. That indicates that the factory default configuration has been restored.

SCREEN INDICATORS

For Internal Use Only. Not for Distribution.

Screen Indicators

The back panel display screen is programmed to display a variety of indicators in addition to the measurement displays.

The screen displays 21 different indicators at various times to show such things as the units the instrument is using for measurement and the mode the instrument is operating in.

When you first power on the instrument, every indicator on the screen displays for a brief time. (You can extend that time by holding the trigger pressed.) With every indicator showing, the screen looks like this:

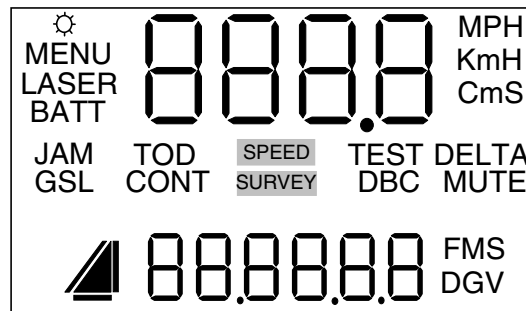

The table that begins on the next page lists and explains each indicator.

SCREEN INDICATORS

For Internal Use Only. Not for Distribution.

Note: Your UltraLyte instrument may not have all the features indicated in this table.

Indicator	Feature Indicated	Explanation
	Display Backlight	The display backlight is on.
MENU	Options menu	You are in the instrument's option menu.
LASER	Laser fire	The instrument's laser is firing.
BATT	Battery	Blinking: the instrument's batteries are low. Solid: you are in the battery test display.
MPH, KmH, CmS	Speed units	MPH=Miles Per Hour, KmH=KiloMeters per Hour, CmS=CentiMeters per Second
JAM	Jam detection	Indicates a jamming signal.
GS	Gate - Short	Artificially restricts the minimum range of the instrument.
G L	Gate - Long	Artificially restricts the maximum range of the instrument.
TOD	Time Over Distance	Alternate speed measurement mode in which, rather than directly measuring a target's speed, the instrument derives average speed by measuring how long it takes a target to traverse a known distance.
CONT	Continuous mode	Alternate speed measurement mode in which the instrument continuously acquires speed measurements while the trigger is held down.

SCREEN INDICATORS

For Internal Use Only. Not for Distribution.

SPEED	Speed mode	The instrument is taking speed measurements.
SURVEY	Survey mode	The instrument is taking survey (distance) measurements.
TEST	Test mode	The instrument is performing any of several various self-tests.
DBC	Distance Between Cars	Alternate speed measurement mode in which the instrument measures the time and distance separation between two moving vehicles in succession. <i>Not currently available on the instrument.</i>
DELTA	Distance Difference	Distance difference test mode. See “Instrument Confidence Check” for details.
MUTE	Mute (silent) mode	The instrument indicator sounds have been turned off.
	Survey icon	Indicates the survey measurement being taken. The particular elements of the icon vary with the measurement. See “Survey Measurements.”
F, M	Distance units	Units in which distance measurements are being recorded. F = feet, M = meters
S	Time unit	In TOD mode, the time (in seconds) the target took to travel the distance.
D, G	Inclination units	Units for inclination measurements (UL200 only). D = degrees, G = gradients
V	Power units	Battery voltage indicator.

MENU OPTIONS

For Internal Use Only. Not for Distribution.

Menu Options

The following table lists the options available through the Menu/Options button. **Note:** Your UltraLyte instrument may not have all the options listed.

Option	Screen Indicators	Explanation
Display Intensity	br	Varies the in-scope display brightness.
Gate - Short	GS	Artificially restricts the minimum range of the instrument.
Gate - Long	G L	Artificially restricts the maximum range of the instrument.
Measurement units	F, M, MPH, KmH, CmS, D, G	Sets the units to be used to take measurements.
Continuous mode	CONT	Alternate speed measurement mode in which the instrument measures the average speed of a target over an operator-determined measurement time.
Mute mode	MUTE	Toggles instrument indicator sounds on and off.
Power Time-outs	ALL on	Toggles instrument and display time-outs on and off.
Download Formats	20.20.Cr, UL100, UL200	Toggles the formats in which data will be downloaded from the instrument.
Reference Frequency	rEF F out	Dedicated feature for instrument service.

LISTENING TO THE INSTRUMENT

For Internal Use Only. Not for Distribution.

Listening to the Instrument

The UltraLyte emits a variety of ticks and tones when it takes readings. The sounds vary depending on what the instrument is doing, and with experience you can tell what is happening during a measurement simply by listening.

The tones it emits are summarized in the table at right.

Sound	Meaning
Single high-pitched tone	The instrument succeeded in taking the intended measurement.
Single low-pitched tone	The instrument was unable to take the intended measurement due to an error. An error code displays on the back panel screen to indicate the nature of the error. See <i>Error Indicators</i> , later in this manual, for details.
Low-pitched growl	The instrument is attempting to lock onto a target.
Fast ticking	In Time Over Distance mode, the instrument is timing the intended target.
High-pitched, oscillating ring	Jam tone. The instrument's laser return sensor is being overwhelmed by light.

EDIT MODE

For Internal Use Only. Not for Distribution.

Edit Mode

The UltraLyte has an editor that can be used to manually enter numeric values for various instrument settings. You may need to enter values manually in order to use Time Over Distance mode, for example, or to set the value of the short or long gate.

You can invoke edit mode by pressing the Select/Edit button and holding it down for about 2.5 seconds. That action causes the first digit of the appropriate numeric display to begin blinking. For example:

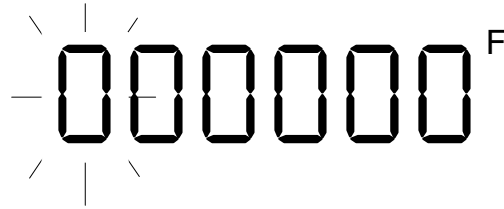

Once in edit mode, the instrument exhibits the following behavior:

- Select/Edit selects the next digit to the right. If the right-most digit is already selected, exits edit mode and saves the current value. The instrument stays in the current menu.
- Backlight/Edit Dn subtracts 1 from the currently selected digit. Holding the button down auto-repeats the operation.
- Test/Edit Up adds 1 to the currently selected digit. Holding the button down auto-repeats the operation.
- Speed/Options or Survey/Options exits edit mode, saves the current value, and goes directly to speed or survey measurement.
- If negative numbers are allowed, Test/Edit Up or Backlight/Edit Dn toggles the first character between 0 and a minus sign.

BASIC SPEED MEASUREMENT

For Internal Use Only. Not for Distribution.

Basic Speed Measurement

When you power on the instrument, the LCD screen on the rear panel shows a display like this one:

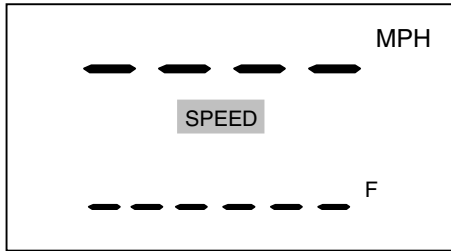

To demonstrate the measurement process, aim to a convenient target through the sighting scope—an interior wall will do—and press the trigger twice; the first press turns on the scope aiming dot and projects it onto the scope face, the second takes the measurement. Or, if you press and hold the trigger down, the red dot will turn on and the instrument will begin a measurement about three-quarters of a second later.

When the instrument succeeds in taking a measurement, you experience three actions.

First, you hear a high-pitched beep from the instrument.

Second, you see the speed measurement projected onto the scope just below the aiming dot. (For this example, the speed is 0 or -0).

Third, the screen on the rear panel shows a display like this:

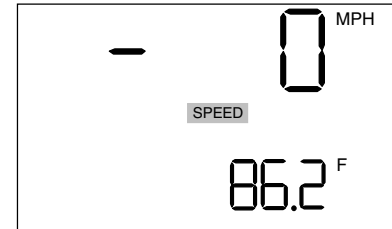

BASIC SPEED MEASUREMENT

For Internal Use Only. Not for Distribution.

The figure at the top of the screen is the target's speed. The figure at the bottom of the screen is the target's distance from the mid-point of the instrument.

Measuring a Moving Vehicle

To measure the velocity of a vehicle using the UltraLyte, use the following procedure:

1. Aim the instrument at the license plate area of the target vehicle and squeeze the trigger. A low-pitched growl begins, indicating the instrument is trying to acquire a lock on the target.
2. Keep the trigger pressed and the instrument sighted on the target until you hear a beep. A high-pitched beep means that a speed was captured; a low-pitched beep, that a measurement error occurred.

The speed calculated for the target displays in the LCD and in the scope. If the target was going

away from you when it was measured, the speed displays as a negative number; if the target was approaching, the speed displays as a positive number.

As long as the trigger is kept pressed, your UltraLyte instrument may retry the speed measurement, depending upon its configuration, up to 10 times or more. Consequently, **it is very important that the aiming point on the target remain constant for the entire measurement time.** If you move the instrument off the aiming point, it cannot capture a speed reading and displays an error message instead.

The JAM Indicator

If your instrument is configured for it, the JAM indicator on the back panel screen may blink during a measurement, accompanied by the jam tone. It indicates that the instrument is being flooded by light and has had difficulty detecting its own signal.

BASIC SPEED MEASUREMENT

For Internal Use Only. Not for Distribution.

It means one of two things: either you are targeting a strong light source such as headlights, or a targeted vehicle is employing a laser jamming device.

Regardless of the level of interference, you will never get an erroneous speed reading. At a low level of interference, you will get a good speed reading, even though the jam tone sounds and the indicator blinks. At a high level of interference, you will get an E06 error condition.

Line of Sight

You must at all times have a clear line of sight to the target vehicle. If an object intersects the beam while a velocity measurement is being taken, an error message displays.

The Cosine Effect

If a target vehicle is moving directly toward or away from you, the velocity measured by the UltraLyte is identical to the vehicle's true speed.

For safety, however, the instrument is usually set up on the side of the road, resulting in an angle between the instrument's position and the target vehicle's direction of travel. When the angle is significant, the measured speed is less than the target's true speed. The phenomenon is known as the "cosine effect." ("Cosine" is a trigonometric function related to the phenomenon.)

The difference between the measured speed and the true speed depends upon the angle between the instrument's *ideal* position—the position where targets would be moving in direct line with the instrument—and its *actual* position. The larger the angle, the lower the measured speed. The effect always works to the motorist's advantage.

Loosely speaking, the cosine effect is not significant as long as the angle remains small. The following table shows the effect:

BASIC SPEED MEASUREMENT

For Internal Use Only. Not for Distribution.

Measured Speed by Angle: The Cosine Effect					
Angle	True Speed				
(degrees)	30 mph	40 mph	50 mph	60 mph	70 mph
Measured Speed (mph)					
0	30.00	40.00	50.00	60.00	70.00
1	29.99	39.99	49.99	59.99	69.99
3	29.96	39.94	49.93	59.92	69.90
5	29.89	39.85	49.81	59.77	69.73
10	29.54	39.39	49.24	59.09	68.94
15	28.98	38.64	48.30	57.94	67.61
20	28.19	37.59	46.99	56.38	65.78
45	21.21	28.28	35.36	42.43	49.50
90	00.00	00.00	00.00	00.00	00.00

The cosine effect decreases as the range to the target vehicle increases. At the maximum range of the instrument, the vehicle is so far away that the

angle between it and the instrument is very small indeed, and the instrument's perception of the target's speed is identical to its true speed. As the vehicle approaches, however, the angle increases until it becomes large enough to affect the measurement.

To minimize the cosine effect, keep the angle small by setting up the instrument as close to the road as possible without creating safety risks, and target down the road at ranges sufficient to keep the angular difference small.

The following chart shows acceptable parameters for minimizing the cosine effect. The chart indicates the percentage of true speed measured, given the distance from the roadway and the distance from the target vehicle. To find a target's measured speed, multiply the true speed by the number in the chart.

BASIC SPEED MEASUREMENT

For Internal Use Only. Not for Distribution.

Distance off the Roadway (feet)	Percentage of True Speed Measured				
	Range to Target Vehicle				
	100 ft	250 ft	500 ft	1000 ft	2000 ft
	fraction of true speed that will be measured				
10	.9950	.9992	.9998	.9999	1.0000
25	.9682	.9950	.9987	.9997	.9999
50	.8660	.9798	.9950	.9987	.9997
100	.0000	.9165	.9798	.9950	.9987
200	.0000	.6000	.9165	.9798	.9950

The diagonal created by the boldface numbers indicates the boundary between acceptable and unacceptable parameters. Numbers above the diagonal are acceptable margins of error; numbers below are unacceptable.

A good rule of thumb is not to exceed 10 feet off the road for every 100 feet shooting down range to the targets. If you want to target vehicles 500 feet down the road, for example, set up no more than 50 feet off the road.

Remember that the cosine effect is always in the motorist's favor.

TIME OVER DISTANCE MEASUREMENT

For Internal Use Only. Not for Distribution.

Time-Over-Distance Measurement

Time-Over-Distance (TOD) is an alternative method of measuring the speed of a moving vehicle. In TOD measurements, you do not directly measure the vehicle's speed. Instead, you determine the distance between two reference points, and use the precise timing of the UltraLyte to measure how long it takes the vehicle to travel that distance.

The basic procedure is this:

1. Locate two suitable reference points.
2. Enter the distance between the two points (the "reference distance") into the instrument.
3. Position yourself at a convenient spot where you can clearly see both reference points.
4. Signal the instrument to start timing when the vehicle passes the first reference point.
5. Signal again when the vehicle passes the second point.
6. The instrument displays the vehicle's average speed over the course.

TIME OVER DISTANCE MEASUREMENT

For Internal Use Only. Not for Distribution.

Entering the Distance Manually

If you already know the distance between the two reference points, you may enter it directly into the instrument. Use this procedure:

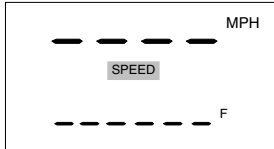
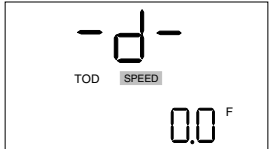
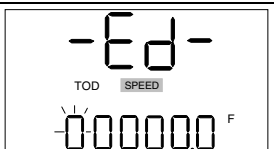
Action	Result
1. Power on by pressing the trigger.	
2. Press the Speed/Options button (right button panel) to invoke TOD mode.	
3. Press and hold the Select/Edit button to invoke edit mode.	

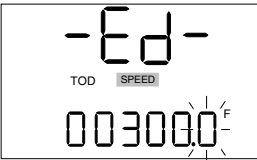
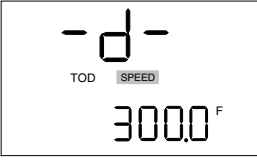
Action	Result
4. Edit in the distance. (For this example, we use 300 feet.) Select/Edit selects digits. Test/Edit Up increments a digit, Backlight/Edit Dn decrements it.	
5. When you have set the right-most digit, press Select/Edit once more to exit edit mode and return to the TOD screen. The distance you entered displays in the bottom display area.	

TIME OVER DISTANCE MEASUREMENT

For Internal Use Only. Not for Distribution.

Measuring the Distance

If you use the instrument to calculate the reference distance, make sure the reference points you've chosen form a straight line parallel to the path of traffic.

There are two ways to measure the distance between the points.

One way is to stand in a spot that forms a straight line with your two reference points—or as near to a straight line as you can manage and still see both points clearly. Then measure both points. The instrument calculates the distance difference. The difference is equal to the distance between the points. For example:

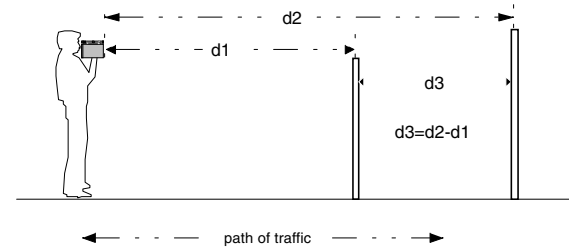

Another way is to stand at one reference point and measure directly to the other, like this:

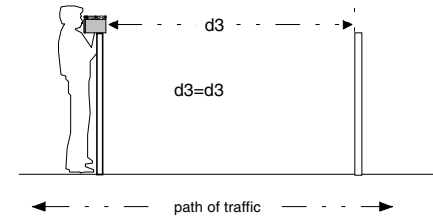

Decide which method you will use and, when you are properly positioned, follow this procedure:

TIME OVER DISTANCE MEASUREMENT

For Internal Use Only. Not for Distribution.

Action	Result
1. Press Speed/Options (right button panel) repeatedly until the TOD screen displays.	<p>The screen displays a large 'd' between two horizontal dashes. Below the 'd' are the labels 'TOD' and 'SPEED'. At the bottom right, the number '0.0' is displayed with a small 'F' superscript.</p>
2. Press the trigger to go to the first distance display.	<p>The screen displays 'd1' between two horizontal dashes. Below 'd1' are the labels 'TOD' and 'SPEED'. A dashed line is shown below the dashes, ending with a small 'F'.</p>
3. Aim to the near reference point and press the trigger. The screen displays the distance.	<p>The screen displays 'd1' between two horizontal dashes. Below 'd1' are the labels 'TOD' and 'SPEED'. The number '50.1' is displayed with a small 'F' superscript.</p>
4. Press Select/Edit to go to the second distance display.	<p>The screen displays 'd2' between two horizontal dashes. Below 'd2' are the labels 'TOD' and 'SPEED'. A dashed line is shown below the dashes, ending with a small 'F'.</p>

Action	Result
5. If you are measuring directly from one reference point to the other, skip this step. Aim to the far reference point and press the trigger. The screen displays the distance.	<p>The screen displays 'd2' between two horizontal dashes. Below 'd2' are the labels 'TOD' and 'SPEED'. The number '350.1' is displayed with a small 'F' superscript.</p>
6. Press Select/Edit. You return to the main TOD screen, which displays the distance between the two reference points.	<p>The screen displays a large 'd' between two horizontal dashes. Below the 'd' are the labels 'TOD' and 'SPEED'. At the bottom right, the number '300.0' is displayed with a small 'F' superscript.</p>

TIME OVER DISTANCE MEASUREMENT

For Internal Use Only. Not for Distribution.

Taking the Measurements

Once the reference distance has been established, station yourself at any position convenient for observing both reference points. Measure speeds with this procedure:

The final display has two measurements. The one at the top of the screen is the speed calculation; the one at the bottom is the number of seconds it took the vehicle to pass between the two reference points.

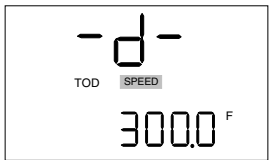
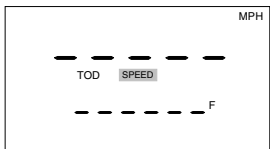
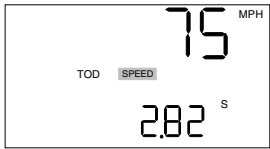
Action	Result
1. You should already be at the TOD screen. (If not, press Speed/Options to display it.)	 <p>The screen displays a large 'd' between two horizontal dashes. Below the 'd' are the labels 'TOD' and 'SPEED'. At the bottom, the number '300.0' is displayed with a small 'F' to its right.</p>
2. Press Select/Edit. The measurement screen displays.	 <p>The screen shows two horizontal dashed lines. The top line is labeled 'MPH' on the right. Below the lines are the labels 'TOD' and 'SPEED'. At the bottom right, a small 'F' is visible.</p>
3. When a vehicle passes one point, press the trigger to begin timing. When the vehicle passes the second point, press the trigger to stop.	 <p>The screen displays '75' in large digits with 'MPH' to its right. Below this, the labels 'TOD' and 'SPEED' are visible. At the bottom, the number '2.82' is displayed with a small 'S' to its right.</p>

TIME OVER DISTANCE MEASUREMENT

For Internal Use Only. Not for Distribution.

Notes on Using TOD

- Reference points can be any visually detectable and stationary marks on or near the roadway.
- If you are measuring the distance with the UltraLyte, make sure you are directly in line with both targets.
- It's important that you use the same part of the vehicle to start and stop timing. If you start the clock when the headlights pass the first reference point, for example, stop the clock when the headlights pass the second. In that way, your response time pressing the trigger assures a consistent measurement.
- When you start the clock, the instrument begins to tick so you know the clock is running. The ticking noise continues until you stop the clock.
- You may continually clock vehicles between the chosen reference points. The distance originally entered is used to calculate the speed of each vehicle.
- To set up for a different pair of reference points, exit back to the main TOD screen by pressing the Select/Edit button. Then repeat the procedure for entering the distance.
- The instrument remembers the distance entered even with power turned off. When you power back on, press the Speed/Options button, then the Select/Edit button to re-enter TOD and resume clocking vehicles.
- TOD determines the average speed of a vehicle over a measured distance; it does not capture peak speed.

SURVEY MEASUREMENTS

For Internal Use Only. Not for Distribution.

Survey Measurements

In any survey, there are four measurements to be taken: slope distance, inclination, horizontal distance, and vertical distance. The following illustration defines the measurements and illustrates the relationships among them:

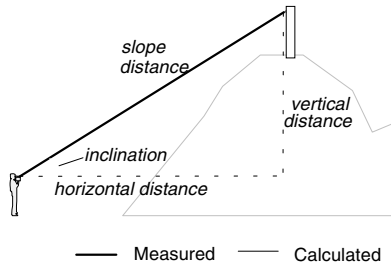

The UltraLyte 100 has no way to measure angles, and takes only slope distance measurements. The UltraLyte 200, however, has a tilt sensor that allows it to measure inclination as well as slope distance. From those two measurements, horizontal and vertical distances can be calculated.

The triangle icon in the lower left corner of the display screen indicates the measurement you are taking. The icons are summarized in the following table:



Icon	Measurement
	Horizontal distance
	Vertical distance
	Slope distance
	Inclination angle

SURVEY MEASUREMENTS

For Internal Use Only. Not for Distribution.

Taking the Measurement

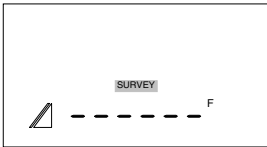
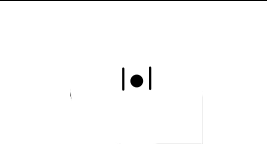
To see how the UltraLyte takes survey measurements, choose a target 20 or 30 feet away from you. For this exercise, the target can be as simple as, say, a wall at the end of the corridor outside your office or the fence around your backyard. Then follow this procedure:

Do this...	...to get this result:
1. Press Survey/ Options to activate survey mode. (With a UL100, you get a slope distance icon. With a UL200, you get a horizontal distance icon.)	
2. Press the trigger to turn on the scope aiming dot, and sight the target through the scope	
3. Press the trigger.	

You have just taken a distance measurement to your fence, or whatever target you chose.

Each survey measurement operates in the same simple, aim-and-fire way. Just be sure you are taking the right measurement, as indicated by the icon. If the correct indicator isn't showing, press the Survey/Options button until it is.

In-scope Display

When you sighted through the scope, you probably noticed the in-scope display looked different than it did when you were taking the speed measurement. In survey mode, the in-scope aiming dot is flanked by vertical lines:

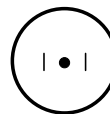

The lines are there to signify that you are in survey mode, and that any numerical display represents a survey measurement, not a speed.

For Internal Use Only. Not for Distribution.

Grouping Sensors on a UL200

The UltraLyte 200 takes only those sensor readings necessary to satisfy the current option. A feature is available to manually “group” the sensors by taking a separate reading with each sensor. Then by scrolling to another option the instrument will combine those readings to calculate other related measurements.

For example, when slope distance is measured, the range sensor is activated but the tilt sensor is not. However, a horizontal or vertical distance measurement requires readings from both sensors. The straightforward way of measuring horizontal or vertical distance is to simply shoot when the correct indicator is showing so the instrument calculates everything at once.

But suppose, for example, that an obstruction prevents you from taking a reliable reading with one sensor. In that case, you can use the “Group” feature and shoot a slope distance measurement, reposition the instrument, and then take an angle measurement. Then scroll to horizontal or vertical distance, and you will see that the instrument has calculated a distance from your two separate sensor readings.

To activate the Group feature, press and hold Select/Edit until **Grp** appears on the screen. Next, press Survey/Options to select your measurement option. To turn the Group feature off, press and hold Select/Edit again until you hear a beep and **Grp** disappears. No data is sent out the serial port in Group mode until the feature is turned off and the beep is heard.

When using the Group feature, you may find it helpful to first clear the sensors that you wish to group by quick-pressing the Select/Edit button in the desired menu.

ERROR CONDITIONS

For Internal Use Only. Not for Distribution.

Error Conditions

Error conditions can occur in a measurement or in system hardware. To make sure you never get an erroneous speed reading, the UltraLyte monitors both the system and the measurement. When the instrument detects an error condition, it displays an error code instead of a speed.

Error codes are in the form Exx, where “xx” is an error code number. Error codes display in the numeric display area. In speed mode, for example, errors show at the top of the screen:

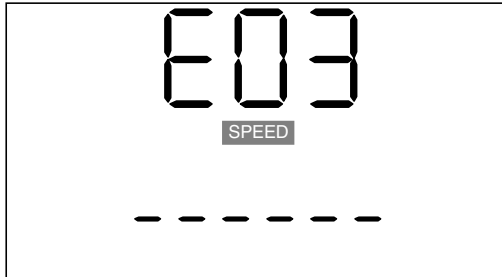

Measurement error conditions typically occur because the instrument could not acquire a target or could not maintain a “lock” on the target. Usually this is caused by a target that is out of range, or by panning the instrument off the target during the measurement attempt.

Most other error conditions are similarly trivial; correcting them requires only that you retry the measurement you were taking.

ERROR CONDITIONS

For Internal Use Only. Not for Distribution.

Error Codes

The possible error indicators are listed and explained in the following table:

Code	Explanation
doF	Display overflow. The measurement exceeds the display capacity. Note that the in-scope numerical display is only four digits, while the screen display is six. It is possible to receive a doF message in the scope and still have a valid measurement displaying on the screen.
EoF	Editor overflow.
E01	Measurement error - target never acquired. The target was out of range or was too close.
E02	Measurement error - insufficient data. The instrument's view was obstructed or the target moved out of range.
E03	Measurement error - unstable targeting. Caused by poor aiming or by panning off the target.
E04	TOD timing error. The target was timed for less than 1 second.

Code	Explanation
E05	TOD time-out. The target was timed for more than 100 seconds.
E07	Jam detect - unable to acquire target.
E52	Temperature too hot. Stop operation.
E53	Temperature too cold. Stop operation.
E57	Tilt sensor communication failure.
E54	Calibration or memory checksum failure. If the error persists, contact Laser Technology.
E55	
E56	
E60	
E61	
E62	
E63	

RFI Considerations

The UltraLyte does not display a specific error message indicating the presence of radio frequency interference (RFI). The instrument electronics have been designed for optimum RFI immunity; if RFI is present, it generates one of the above error codes to display. The exact code is dependent upon the level and nature of the RFI.

IN-SCOPE DISPLAY INTENSITY

For Internal Use Only. Not for Distribution.

In-scope Display Intensity

The in-scope display has 22 intensity settings from off (0) to bright (21). You adjust the brightness with the **br** menu option. Use the procedure in the table at right.

Each time you increase the brightness index by 1, the in-scope display doubles in intensity. The brightness setting displays in the scope as well as on the screen, to make getting the right setting easy.

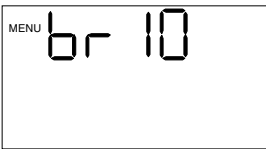
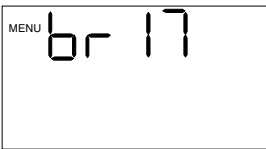
Action	Result
1. Press Menu/Options until the screen displays the br xx option (xx is the current setting).	 The image shows a rectangular display area with the word "MENU" in the top left corner. To the right of "MENU", the text "br 10" is displayed in a large, bold, monospaced font.
2. Press Test/Edit Up or Backlight/Edit Dn until the setting is correct.	 The image shows a rectangular display area with the word "MENU" in the top left corner. To the right of "MENU", the text "br 17" is displayed in a large, bold, monospaced font.
3. Return to speed or survey mode by pressing the appropriate button. Go to the next menu option by pressing Menu/Options.	

GATES AND GATE WINDOWS

For Internal Use Only. Not for Distribution.

Gates and Gate Windows

A “gate” is a way of artificially restricting the minimum or maximum range of the instrument.

When you use the gating feature, the UltraLyte detects no targets nearer than the “short gate” setting or farther than the “long gate” setting. The range within which a target can be detected is called the “gate window.”

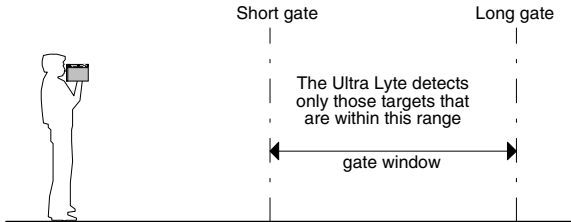

Gating is useful when you must restrict your speed detection operations to a particular area, or during a survey in which partial obstructions present a danger of giving false readings.

Gate Window Characteristics

The gate window you can set has the following characteristics:

- If you set only the short gate and leave the long gate null, the gate window extends from the short gate value to the maximum range of the instrument.
- If you set only the long gate and leave the short gate null, the gate window extends from the minimum range of the instrument to the long gate value. (The minimum range is zero in survey mode, 50 feet (15 m) in speed mode).

GATES AND GATE WINDOWS

For Internal Use Only. Not for Distribution.



- If you set the short gate nearer than 50 feet (15 meters), it defaults to 50 feet in speed mode but assumes its normal value in survey mode.
- The gate window is restricted to a width of 5 feet (1.5 meters). If setting a gate causes the window to be narrower than that, the instrument automatically adjusts by resetting the other gate.

If the short gate is already set at 98 feet, for example, and you set the long gate to 100 feet, the instrument resets the short gate to 95 feet.

- The maximum allowable value of the short gate for a standard UltraLyte is 2000 feet/610 meters for a standard UltraLyte is 2000 feet/610 meters (3998 feet/1218 meters for the UltraLyte LR). The maximum allowable value of the long gate is 2005 feet/612 meters (4003 feet/1220 meters for the UltraLyte LR).

Setting a Gate Value

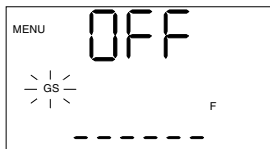
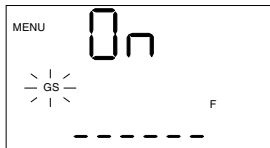
You can set the gates either by entering the values manually or by using the instrument to measure the values. Follow this procedure:

Action	Result
1. Press Menu/Options repeatedly until the appropriate indicators begin to blink. Indicators are G and S for the short gate, G and L for the long gate.	 The display shows 'MENU' in the top left, 'OFF' in large digits in the center, and 'GS' with a blinking indicator in the bottom left. A dashed line is at the bottom.
2. Turn on the gate by pressing and releasing the Select/Edit button.	 The display shows 'MENU' in the top left, '0n' in large digits in the center, and 'GS' with a blinking indicator in the bottom left. A dashed line is at the bottom.
3. To measure the distance with the UltraLyte, aim to a target that marks the location of the gate and press the trigger. Then go to step 6.	
4. Start edit mode by pressing Select/Edit and holding it down for 2.5 seconds.	 The display shows 'MENU' in the top left, '0n' in large digits in the center, and 'GS' with a blinking indicator in the bottom left. A numeric keypad is visible at the bottom.

GATES AND GATE WINDOWS

For Internal Use Only. Not for Distribution.

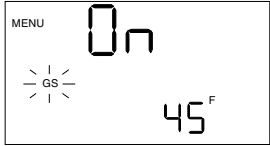
Action	Result
5. Enter the gate value with the standard edit mode keys.	 A screenshot of the instrument's LCD display. The word 'MENU' is in the top left corner. The word 'On' is displayed in large characters in the center. Below 'On' is a small icon of a sun with rays and the letters 'GS' in the center. In the bottom right corner, the number '45' is displayed with a small 'F' superscript.
6. Return to speed or survey mode by pressing the appropriate button. Go to the next menu option by pressing Menu/Options.	

Turning Off a Gate

To turn off a gate that is currently set on, press Menu/Options until you get the first **GS** or **GL** screen. The screen shows “On” and displays the current gate value.

Press Select/Edit to turn the gate off.



Even when the gate is off, the instrument saves the value. You can go back in later and turn the gate back on, and you will still have the same value settings as before.

MEASUREMENT UNITS

For Internal Use Only. Not for Distribution.

Measurement Units

The UltraLyte takes survey and range measurements in English or metric units. If your instrument's configuration allows the units to be changed, use this procedure to select feet or meters:

Action	Result
1. Press Menu/Options repeatedly until the screen shows SEL and the F or M indicator.	
2. Press the Select/Edit button to change the indicator to M or F .	
Return to speed or survey mode by pressing the appropriate button. Go to the next menu option by pressing Menu/Options.	

Select angle units in the UL200 in the same way: press Menu/Options repeatedly until the screen shows SEL and the current units indicator begins blinking. Then press Select/Edit to get the indicator you want.

Notes

- Your instrument may not have all the different units activated, depending upon the instrument's configuration.
- Switching between feet and meters resets gate values to null and resets the TOD distance to zero.
- Speed measurement units cannot be changed.

CONTINUOUS MODE

For Internal Use Only. Not for Distribution.

Continuous Mode

“Continuous mode” is an operating mode in which the UltraLyte takes speed measurements continuously until you release the trigger.

Normally when the instrument takes a speed measurement, it takes and displays only one reading and then stops, even if you hold down the trigger the entire time. To take a second reading, you must release the trigger and press it again.

If you wish to take several successive readings on a target, however, you can put the instrument in continuous mode. In that case, the instrument takes and displays one reading after another, and continues to take and display readings as long as you hold down the trigger. Release the trigger, and the instrument finishes its latest reading and stops. If an error code is shown when you release the trigger, the instrument will display either the most recent speed reading, or, if the error code has persisted for several tries, the error code will remain.

To turn continuous mode on or off, follow this procedure:

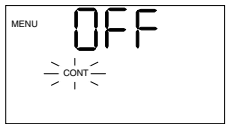
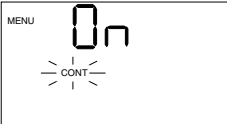
Action	Result
1. Press Menu/Options repeatedly until the CONT indicator blinks, and the screen shows OFF or On.	
2. Press the Select/Edit button to turn continuous mode on or off.	
3. Return to speed or survey mode by pressing the appropriate button. Go to the next menu option by pressing Menu/Options.	

For the best results, do not try to use continuous mode to target one vehicle after another. When you wish to change targets, release the trigger, aim to the new target, and retrigger.

MUTING THE INSTRUMENT

For Internal Use Only. Not for Distribution.

Muting the Instrument

When the UltraLyte is taking readings, it normally makes a variety of audible signals to help inform you of its operational condition. High-pitched beeps signal a successful measurement, for example, and low-pitched beeps indicate an error.

If you prefer the instrument to be silent, or if you are in relatively close quarters with potential targets—pedestrians or bicyclists, for example—who might be warned or startled by noise from the instrument, you can mute the instrument so it makes no noise.

When mute is on, LAS appears in the scope to let you know that the laser is firing. Next, the in-scope aiming dot disappears to let you know that the measurement has completed, an indication similar to the high or low pitch tone in normal mode.

Muting is a menu option. Turn it on or off with the following procedure:

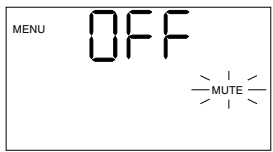
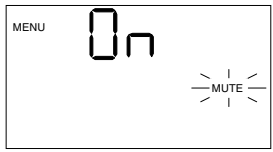
Action	Result
1. Press Menu/Options repeatedly until the MUTE indicator blinks, and the screen shows OFF or On.	 The screenshot shows the word 'MENU' in the top left corner. In the center, the word 'OFF' is displayed in a large, digital font. In the bottom right corner, there is a 'MUTE' indicator consisting of the word 'MUTE' with a central dot and four short lines extending outwards, indicating it is active and blinking.
2. Press the Select/Edit button to turn mute on or off.	 The screenshot shows the word 'MENU' in the top left corner. In the center, the word 'On' is displayed in a large, digital font. In the bottom right corner, there is a 'MUTE' indicator consisting of the word 'MUTE' with a central dot and four short lines extending outwards, indicating it is active and blinking.
3. Return to speed or survey mode by pressing the appropriate button. Go to the next menu option by pressing Menu/Options.	

POWER CONSERVATION INTERVALS

For Internal Use Only. Not for Distribution.



Power Conservation Intervals

To help conserve its batteries, the UltraLyte has three timed power-off intervals: one for the in-scope numerical display, one for the in-scope aiming dot, and one for the instrument as a whole. Lack of instrument activity for an interval causes the associated function to shut down. The following table summarizes the time-outs:

Function	Interval	Effect of Time-out
In-scope numerical display	3 sec.	The numerical display shuts off
In-scope aiming dot	20 sec.	Aiming dot shuts off
Instrument	10 min. (approx.)	Power shuts down

The in-scope display time-outs cannot be turned off. The instrument time-out, however, can be.

Follow this procedure:

Action	Result
1. Press Menu/Options repeatedly until the ALL on indicator blinks, and the screen shows On (or OFF).	 <p>The screenshot shows a digital display with the word 'On' in the upper right. Below it, the text 'ALL on' is displayed with vertical lines on either side, indicating a blinking status. The word 'MENU' is visible in the top left corner.</p>
2. Press the Select/Edit button to turn the time-out on or off.	 <p>The screenshot shows a digital display with the word 'OFF' in the upper right. Below it, the text 'ALL on' is displayed with vertical lines on either side, indicating a blinking status. The word 'MENU' is visible in the top left corner.</p>
3. Return to speed or survey mode by pressing the appropriate button. Go to the next menu option by pressing Menu/Options.	

Use care. Disabling the power-off interval prevents the instrument from automatically shutting off; it must be manually turned off or the battery life will be greatly reduced.

For Internal Use Only. Not for Distribution.

Setting Download Formats

The UltraLyte back panel contains a serial connector that lets you download data to a data collector or computer. The messages containing the data vary in format, depending upon the format mode that has been selected.



There are two format modes:

- 20-20/Criterion format
- UltraLyte native format

In 20-20/Criterion mode, speed and range messages are downloaded in the format used by the Laser Technology 20-20 speed gun, and survey messages are downloaded in the format used by the Laser Technology Criterion survey instruments.

In native mode, all messages are downloaded in UltraLyte native format.

You select the format mode with the following procedure:

Action	Result
1. Press Menu/Options repeatedly until the screen shows SEr and the indicator for the current mode.	
2. Press the Select/Edit button to toggle the mode indicator. The mode indicators are 20.20.Cr , UL100 , and UL200 .	
3. Return to speed or survey mode by pressing the appropriate button. Go to the next menu option by pressing Menu/Options.	

For specific information about available download formats, see [Appendix A](#).

TESTING DISPLAY INTEGRITY

For Internal Use Only. Not for Distribution.

Testing Display Integrity

The back panel and in-scope displays are segmented. A test has been incorporated into the instrument to verify that all segments are operating.

To initiate the test, press Test/Options. The following screen displays:

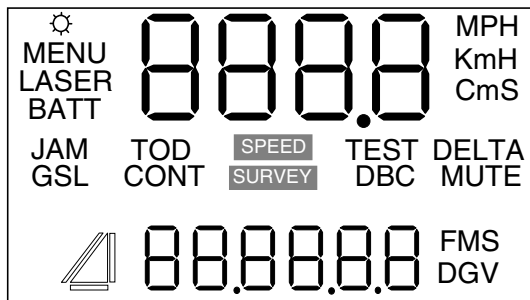

Press Select/Edit to toggle the displays on and off. If you do not toggle off, the in-scope display times out after 5 seconds.

If any segment fails to display, contact Laser Technology to arrange repair.

Note that you may also test the back panel display integrity at power on, by holding the trigger pressed.

For Internal Use Only. Not for Distribution.

Scope Alignment Test

This test ensures the accuracy of the UltraLyte's targeting mechanics, and should be performed periodically.

1. *Put the instrument in test tone mode.* Press the Test/Options button repeatedly until the display reads "tt," which stands for *test tone*. When test tone mode is active, pressing the trigger generates an audible tone. The tone's pitch is related to the strength of the laser pulse returned to the instrument: a high tone indicates a strong return, a low tone indicates a weak one.
2. *Select a target.* Choose a prominent target with definitive horizontal and vertical edges. The target's reflective qualities and distance from you should be such that you can clearly hear a change in the pitch of the test tone when you pan the instrument over the edges of the target. (A telephone pole is an excellent choice.) Make sure there is nothing behind the target the instrument might detect, so you know without doubt that any change in pitch is due strictly to the target.

3. *Scan the target.* Press and hold the trigger while panning the instrument across the target. The tone changes pitch when the instrument acquires the target. The highest pitch—the "on target" tone—should occur when the scope's red aiming dot is centered on the target.

Scan the target both horizontally and vertically, making certain the pitch decreases evenly off each side of the target. If there is any discrepancy between the "on-target" tone and the position of the red aiming dot, perform the realignment procedure (see *Realigning the Scope* on page 54).

Note: When checking vertical alignment to a close target, be aware of the offset between the center of the scope and the center of the transmit lens, which is 2 inches.

BATTERY VOLTAGE DETECTION

For Internal Use Only. Not for Distribution.

Battery Voltage Detection

The battery voltage detection feature ensures that the instrument always has sufficient battery voltage to guarantee correct operation.

The UltraLyte continuously monitors its power source. If the battery voltage drops during operation, the **BATT** indicator blinks:

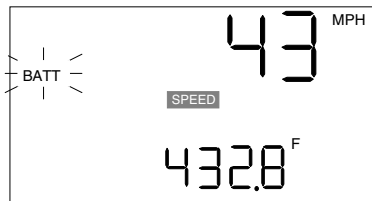

If you fail to change the batteries and the voltage drops even further, the button panels lock out.

You can also test the batteries manually. Simply press Test/Options repeatedly until the **BATT** indicator displays, along with the voltage level. For example:

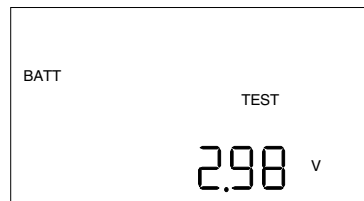

The nominal full charge is 3.0V. If the voltage reading is less than about 2.4V, you should replace the batteries at the first opportunity. At 2.2V the low battery indicator begins to blink; at 2.0V the button panels lock out.

INSTRUMENT CONFIDENCE CHECK

For Internal Use Only. Not for Distribution.

Instrument Confidence Check

The measurement accuracy of a lidar instrument can be verified by several methods. Verifying it directly, however—by measuring the velocity of an object traveling at a known speed—is seldom practical. And the nature of lidar is such that it cannot be tricked by a vibrating object, such as a tuning fork, into displaying a velocity. For those reasons, LTI has designed two passive test procedures.

The tests are the *fixed distance check* and the *delta distance check*. The point of the tests is to verify the accuracy of the two key elements of lidar speed measurement: precise time measurements and the ability to make mathematical calculations.

LTI recommends that one of the tests be performed on the instrument each time it is taken on duty. Regardless of which test you intend to perform, we also suggest a test area be permanently installed in a convenient location.

The test area must establish permanent, known distances between a target and a shooting mark (fixed distance test) or between two targets and a shooting mark (delta distance test). The targets and the shooting mark must form a straight line. Keep in mind that the minimum measurement distance for these tests is 50 feet.

A target can be any flat, permanent structure—a sign or wall, for example—painted with a bull's eye or other aiming point. The shooting mark is where an operator stands to conduct the test, and can be an X painted on the pavement.

Testing and test-area specifics are discussed below. There are two things you should note, however.

First, the distances specified are *horizontal* distances. (A horizontal distance is measured along a straight and level path from the shooting mark to the center of the aiming point.)

INSTRUMENT CONFIDENCE CHECK

For Internal Use Only. Not for Distribution.

Second, the manner in which you stand and the manner in which you hold the instrument both affect the test measurements. For exact readings, carefully hold the instrument so it is directly over the middle of the X.

Fixed Distance Check

The fixed distance test requires only one target. For uniformity, it should be 175 feet from the shooting mark. To ensure the distance is accurate, use a metal tape to measure it. (If there is insufficient space available, that specific distance is not crucial. However, the distance between the target and the shooting mark must be a multiple of one foot; a fraction of a foot will not do.)

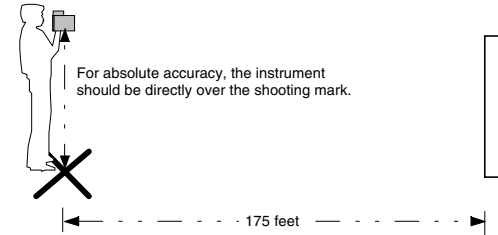

The test procedure is as follows:

1. Stand on the shooting mark and aim the UltraLyte at the target. Squeeze and release the trigger.
2. Check the back panel screen. The speed reading should be zero. (A reading of zero verifies the timing accuracy of the instrument, and is identical in nature to an accurate velocity reading of a vehicle moving at *any* speed.) The distance reading should be 174, 175, or 176.

INSTRUMENT CONFIDENCE CHECK

For Internal Use Only. Not for Distribution.

Delta Distance Check

The delta distance check requires two targets. For uniformity, the first target should be 150 feet from the shooting mark, and the second should be 175 feet from the mark. To ensure accurate distances, use a metal tape to measure them. If there is insufficient space available, those specific distances are not crucial. However, the distance between the two targets and the distances from the targets to the shooting mark must be multiples of 1 foot.

One way to get the elements positioned is to first install the farther target. Then measure 175 feet to the shooting point and mark the spot. Finally, measure from the shooting mark 150 feet to the second target. Mark that spot and install that target.

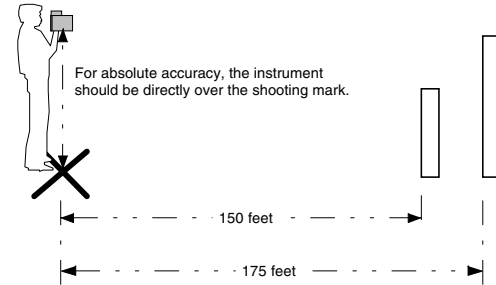

To conduct the test, stand on the shooting mark and follow the procedure on the next page.

Note that, for display purposes, each measurement is rounded to whole feet or tenths of meters. The distance difference, however, is calculated and displayed in tenths of feet or in hundredths of meters.

INSTRUMENT CONFIDENCE CHECK

For Internal Use Only. Not for Distribution.

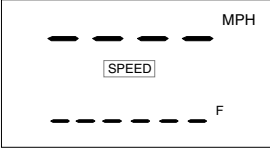
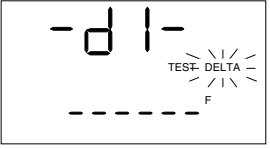
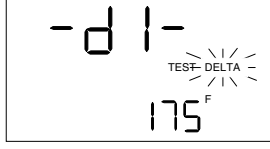
Action	Result
1. Power on by pressing the trigger.	
2. Press Test/Options repeatedly until the screen displays "d1" and the DELTA indicator begins to blink.	
3. Aim to the far target and press the trigger. The screen displays the distance to the target, plus or minus one foot. (If the far target is 175 feet away, the display should read 174, 175, or 176.)	

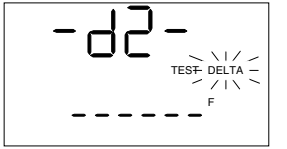
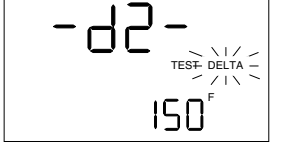
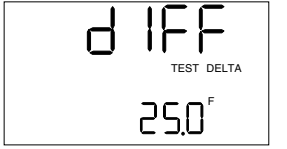
4. Press Select/Edit. The screen displays "d2."	
5. Aim to the near target and press the trigger. The screen displays the distance plus or minus one foot. (If the near target is 150 feet away, the display should read 149, 150, or 151.)	
6. Press Select/Edit. The screen displays the difference between the two distances plus or minus six inches. (If the difference is 25 feet, the display should read from 24.5 feet to 25.5 feet.)	

For Internal Use Only. Not for Distribution.

Maintenance

Operating Temperature

The instrument is rated for a temperature range of -30° C (-22° F) to 60° C (140° F). Do not expose the instrument to temperatures outside that range.

Moisture and Dust Protection

The instrument is sealed to provide protection from normally encountered field conditions. It is protected from dust and from rain, and features temporary submersion resistance.

Shock Protection

The UltraLyte is a precision instrument and should be handled with care. It will withstand a reasonable drop shock. If you drop the instrument, however, check the scope alignment before using the instrument for measurement.

Cleaning and Storage

Clean the instrument after each use, before returning it to its case. Check for the following:

- *Excess moisture.* Towel off excess moisture, and air dry the instrument at room temperature.
- *Exterior dirt.* Wipe exterior surfaces clean. Use isopropanol to remove dirt and fingerprints from the scope exterior.
- *Dirty lenses.* Use a lens brush to remove surface dust and loose particles from the front panel lenses. To clean a lens, moisten it with lens cleaning solution and wipe it with a clean cloth or lens tissue.
- *Batteries.* If you won't be using the instrument again soon, remove the batteries before storing it.

MAINTENANCE

For Internal Use Only. Not for Distribution.

Caring for the Scope

Do not attempt to lubricate the scope. It is sealed from within using O rings and special compounds. All seals are permanent and require no maintenance.

Use a lens brush to remove surface dust and loose particles. To clean a lens, moisten it with lens cleaning solution and wipe it with a clean cloth or lens tissue.

The adjustment screws are permanently lubricated; do not attempt to lubricate them. Keep the cover screws and sealing washers in place except when the scope is being aligned.

Checking the Display Screen

The instrument provides a method of verifying the display integrity. You can do that as described in “[Powering On and Off](#)” and in “[Testing Display Integrity](#),” earlier in this manual.

Resetting Factory Option Defaults

The instrument remembers option settings even with the power turned off. To return options to their factory defaults, use the procedure in [Restoring the Default Configuration](#), earlier in this manual.

REALIGNING THE SCOPE

For Internal Use Only. Not for Distribution.

Realigning the Scope

The scope may become misaligned by a heavy blow to the instrument. The procedure in the table below corrects the alignment. The point of the procedure is to align the laser's point of impact with the scope's red aiming dot, using sound to indicate when the scope is on target.

To align the scope properly, you need:

- *Two metric Allen wrenches* to expose and turn the scope adjustment screws, one 2.5mm and one 1.5mm.
- *A target* at which to aim the instrument.
- *A highly stable base* for the instrument. A tripod is recommended.

Target Selection

Choose your alignment target carefully. The target should be at least 700 ft. (200 m) away. It should be a prominent target with definitive horizontal and vertical edges that will cause a clearly perceivable change in the pitch of the test tone (a telephone pole is an excellent choice). Make certain there are no background objects that the instrument might detect.

REALIGNING THE SCOPE

For Internal Use Only. Not for Distribution.

Adjustment Screws

The scope adjustment screws are in the top front panel of the scope, protected by cover screws. To gain access, remove the cover screws with a 2.5mm Allen wrench.

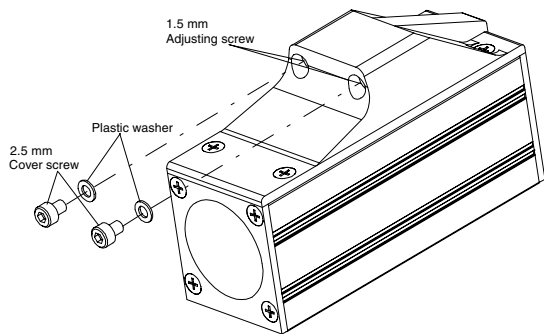

Warning: Each cover screw assembly includes a small plastic washer. It is imperative that you not lose the washers. Failing to replace them renders the scope susceptible to water damage.

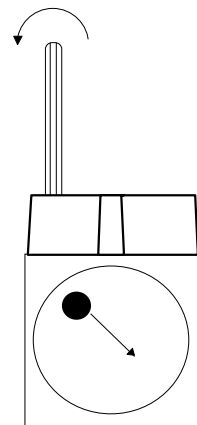

Scope rear view

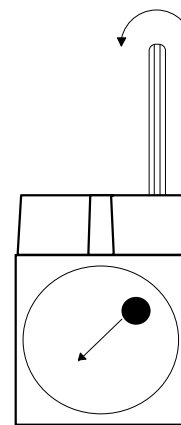

Scope rear view

Once the adjustment screws are exposed, turn them with a 1.5mm Allen wrench to adjust the position of the scope aiming dot, as shown in the following illustration:

REALIGNING THE SCOPE

For Internal Use Only. Not for Distribution.

Realignment Procedure

Action	Result/Notes
1. Steady the instrument on a solid base.	Rest the instrument against a solid support that will help keep the aiming dot steady on the target.
2. Expose the adjustment cover screws.	See "Adjustment Screws" above.
3. Press Test/Options repeatedly until the test tone screen displays.	
4. Select a target.	The target should be at least 700 feet (200 m) away. See "Target Selection" above.
5. Locate the target.	Press and hold the trigger while panning the instrument across the target. When the tone achieves its highest pitch, the laser light beam is hitting the target.
6. Adjust the scope.	Adjust the alignment screws to make the red aiming dot converge with the center of the target.
7. Check the alignment.	Use the alignment test procedure on page 46 to double check the alignment. If the instrument doesn't pass, repeat the realignment procedure.
8. Secure the instrument.	When the instrument passes the alignment test, replace the cover screws.

REALIGNING THE SCOPE

For Internal Use Only. Not for Distribution.

Aligning the Tilt Sensor

The UltraLyte tilt sensor cannot be realigned in the field. If you have problems with inclination measurements, contact Laser Technology, Inc. to arrange to return the instrument to the factory for realignment.

For Internal Use Only. Not for Distribution.

Specifications

Note: these specifications are subject to change.

Weight:	2.95 lb. (1.34 kg)
Size:	8.25 x 2.75 x 11 in (21 x 7 x 28 cm)
Acquisition Time:	Speed mode: 0.4 sec. Survey mode: 0.5 sec. (1 sec. with tilt sensor)
Speed Accuracy:	± 1 mph (± 2 kmh)
Min. Range:	Speed mode: 50 ft (15 m) Survey mode: 0 ft (0 m)
Max. Range - UltraLyte:	2000 ft (610 m)
Max. Range - UltraLyte LR:	4000 ft (1200 m)
Speed Range:	± 200 mph (± 320 kmh)
Range Accuracy:	Speed mode: ± 6" (15 cm) Survey mode: ± 2" (5 cm) To a white target at 150 ft. (45 m), 1σ
Range Resolution:	0.1 ft (0.01 m), Survey mode

Inclination Limits:	± 180 deg.
Inclination Accuracy:	± 0.1 deg. typ.
Beam Divergence:	3 milliradians nominal
Laser Wavelength:	904 nanometers nominal
Temperature Range:	-30°C to +60°C (-22°F to +140°F)
Power:	Two alkaline or NiCad rechargeable C batteries providing up to 25 hours of cordless operation.
Eye Safety:	FDA Class 1 (CFR 21)
Environment:	Waterproof to IP 67 and NEMA 6
Construction:	All aluminum, extruded housing

APPENDIX A

SERIAL INTERFACE SPECIFICATIONS

For Internal Use Only. Not for Distribution.

APPENDIX A: SERIAL INTERFACE SPECIFICATIONS

For Internal Use Only. Not for Distribution.

The UltraLyte serial interface uses RS-232 +/-12V signal levels and data format.

Pin-out assignments for the serial port are:

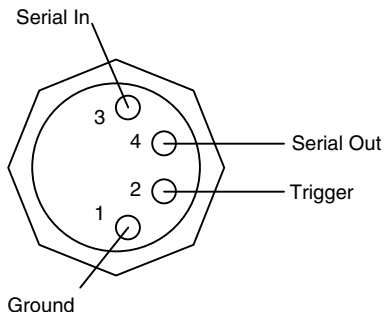

Data Formats

There are three specific data formats:

- UltraLyte (UL) format
- 20/20 format
- Criterion format

The 20/20 and Criterion formats are combined in a single menu selection.

In UL format, the instrument downloads speed measurements in a format specific to the UltraLyte family of speed detection instruments, and downloads survey measurements in a format identical to that of the Laser Technology Impulse family of instruments.

The 20/20 format is identical to that of the Laser Technology Marksman 20/20 speed detection instrument. The 20/20 format is applied only to speed/range measurements, and is provided for those who already possess data collection software for a 20/20 instrument.

The Criterion format is identical to that of the horizontal vector message from the Laser Technology Criterion family of survey instruments. The Criterion format is applied only to survey measurements, and is provided for those who already possess data collection software for the Criterion instrument family.

APPENDIX A: SERIAL INTERFACE SPECIFICATIONS

For Internal Use Only. Not for Distribution.

Criterion formats follow the guidelines of the NMEA 0183 Standard for Interfacing Marine Electronic Navigational Devices, Revision 2.0.

Format Parameters

The format parameters are set to:

- 4800 BPS (Criterion format only)
- 9600 BPS (20/20 and UL format))
- 1 start bit
- 8 data bits
- 1 stop bit
- no parity

Regardless of the format, all data values are automatically available at the serial port after each measurement. Except for version ID requests, the UltraLyte accepts no queries.

Note that when the format is set to 20.20.Cr, the baud rate changes from 4800 BPS in survey mode to 9600 BPS in speed mode.

UltraLyte Download Format

Version Queries

When the serial format is set to UL100 or UL200, the instrument accepts UltraLyte-format requests for the firmware version ID. The request message must be in the format:

\$ID<CR>

where **\$ID** is the request identifier and **<CR>** is a carriage return.

Data is returned in the following format:

\$ID, formatid, versionid *csum<CR>

where:

\$ID

is the message identifier.

formatid

is the download format type (UL100 or UL200).

APPENDIX A: SERIAL INTERFACE SPECIFICATIONS

For Internal Use Only. Not for Distribution.

versionid

is the version number of the instrument's internal software.

**csum*

is an asterisk followed by a hexadecimal checksum. The checksum is the result of a complemented, no-carry, binary addition of all the characters between the dollar sign and the asterisk.

If the first character of the query message is not "\$," there is no response. If the request identifier is not "\$ID," the instrument returns "\$ERR."

Example Version ID Messages

Query:

\$ID

Response:

\$ID,UL100,1.70*22

Speed/Range Data Message Format

A speed and range measurement downloaded in UltraLyte format is in this general form:

\$SP, *speed*, *range*, *sunits*, *runits* **csum* <CR>

where:

\$SP

is the message identifier.

speed

is the measured speed.

range

is the measured range (in whole feet or tenths of meters).

sunits

specifies the speed units. Legal values:

M=Miles per hour

K=Kilometers per hour

C=Centimeters per second

runits

specifies the range units. Legal values are F (feet) and M (meters).

APPENDIX A: SERIAL INTERFACE SPECIFICATIONS

For Internal Use Only. Not for Distribution.

**csum*

is an asterisk followed by a hexadecimal checksum. The checksum is the result of a complemented, no-carry, binary addition of all the characters between the dollar sign and the asterisk.

<CR>

is a carriage return.

If a measurement error occurs, the speed field is occupied by an error code (Exx) and the range field is null. See "Error Conditions" for codes.

Example Speed/Range Messages

English units:

\$SP,50,700.0,M,F*BF

Metric units:

\$SP,80,213.4,K,M*B4

Survey Data Message Format

In UltraLyte format, data is downloaded in the same format as Basic Measurement messages in the Laser Technology Impulse family of instruments. That format is:

\$BM, sd, inc, <null>, hd, vd, du, au *cs <CR>

where:

\$BM

is the message identifier.

sd

is slope distance.

inc

is inclination (null for a UL100).

<null>

is a null field.

hd

is horizontal distance (null for UL100).

APPENDIX A: SERIAL INTERFACE SPECIFICATIONS

For Internal Use Only. Not for Distribution.

vd

is vertical distance (null for a UL100).

du

specifies distance units. Legal values are F (feet) and M (meters).

au

specifies angle units. Legal values are D (degrees) and G (gradients). In a UL100, this field contains the factory default angle units indicator even though the inclination is null.

**cs*

is an asterisk followed by a hexadecimal checksum. The checksum is the result of a complemented, no-carry, binary addition of all the characters between the dollar sign and the asterisk.

<CR>

is a carriage return.

If a measurement error occurs, the message downloads null values for the measurements that failed.

Example Survey Messages

UL100 (English units):

\$BM,27.5, , , ,F,D*E6

UL100 (Metric units):

\$BM,8.38, , , ,M,G*D7

UL200 (English units):

\$BM,27.5,34.8, ,22.6,15.7,F,D*86

UL200 (Metric units):

\$BM,8.38,38.7, ,6.9,4.8,M,G*D0

Criterion Download Format

Version ID Requests

When the serial format is set to **20.20.Cr**, the instrument accepts Criterion-format requests for the firmware version ID. The request message must be in the following format:

APPENDIX A: SERIAL INTERFACE SPECIFICATIONS

For Internal Use Only. Not for Distribution.

\$PLTIT,RQ,ID<CR>[<LF>]

where:

\$PLTIT is the Criterion message identifier

RQ indicates a request message

ID indicates the request type

<CR>[<LF>] is a carriage return and optional linefeed.

The response returned by the instrument is in the following format:

\$PLTIT,ID, model, versionid *csum<CR><LF>

where:

\$PLTIT,ID

identifies the message

model

indicates the UltraLyte model (UL100 or UL200)

versionid

is the version ID of the internal firmware

**csum*

is an asterisk followed by a hexadecimal checksum. The checksum is calculated by XORing all the characters between the dollar sign and the asterisk.

<CR><LF>

is a carriage return/line feed combination, which terminates each Criterion-format message.

Example Version ID Messages

Request:

\$PLTIT,RQ,ID

Response:

\$PLTIT,ID,UL100,1.70*44

APPENDIX A: SERIAL INTERFACE SPECIFICATIONS

For Internal Use Only. Not for Distribution.

Survey Data Message Format

In Criterion format, the UltraLyte downloads survey data messages in this format:

\$PLTIT,HV,hd,hu, , , inc,iu,sd,su*cs<CR><LF>

where:

\$PLTIT

is the Criterion message identifier.

HV

indicates the Criterion Horizontal Vector message type. *Note:* Historically, the HV data line has been the most commonly used of all Criterion data line types, and hence is the only type supplied in the UltraLyte.

hd

is the horizontal distance. In a UL100, this field contains the slope distance.

hu

is the units in which *hd* is expressed. Legal values are F (feet) or M (meters).

Followed by three commas, indicating two null fields for Criterion values not measured by the UltraLyte.

inc

is the inclination measurement. In a UL100, this field always contains 0.00.

iu

is the inclination units. Legal values are D (degrees) or G (gradients). In a

UL100, this field contains the factory default angle units even though the *inc* value is always zero.

sd

is the slope distance.

su

is slope distance units. Legal values are F (feet) or M (meters).

**cs*

is an asterisk followed by a hexadecimal checksum. The checksum is calculated by XORing all the characters between the dollar sign and the asterisk.

APPENDIX A: SERIAL INTERFACE SPECIFICATIONS

For Internal Use Only. Not for Distribution.

<CR><LF>

is a carriage return/line feed combination, which terminates each Criterion-format message.

If a measurement error occurs, the message downloads null values for the measurements that failed.

Example Survey Messages

The sample messages in this subsection use these example values:

Slope distance: 27.5 feet
Horizontal distance: 22.6 feet
Vertical distance: 15.7 feet
Inclination: 34.8 degrees

UL100 (English units):

\$PLTIT,HV,27.5,F, , ,0.00,D,27.5,F*3D

UL100 (Metric units):

\$PLTIT,HV,8.38,M, , ,0.00,G,8.38,M*3E

UL200 (English units):

\$PLTIT,HV,22.6,F, , ,34.8,D,27.5,F*34

UL200 (English units)

\$PLTIT,HV,6.89,M, , ,38.7,G,8.38,M*36

20-20 Download Format

Version ID Requests

When the serial format is set to **20.20.Cr**, the instrument accepts 20/20- and Marksman-format requests for the firmware version ID. The format is as follows:

ID<CR>[<LF>]

APPENDIX A: SERIAL INTERFACE SPECIFICATIONS

For Internal Use Only. Not for Distribution.

where **ID** is the request identifier, **<CR>** is a carriage return, and **<LF>** is an optional line feed character.

The response returned by the instrument is in the following format:

ulmodel -versionid, date, csum<CR><LF>

where:

ulmodel

indicates the UltraLyte model (UL100 or UL200)

-versionid

is the version ID of the internal firmware preceded by a hyphen

date

is the effective date of the firmware version in mm/dd/yy format

csum

is a hexadecimal checksum consisting of the lower two bytes of the firmware checksum.

<CR><LF>

is a carriage return/line feed

Example Version ID Messages

Request:

ID

Response:

UL100-1.70,06/10/97,5FCA

APPENDIX A: SERIAL INTERFACE SPECIFICATIONS

For Internal Use Only. Not for Distribution.

Speed/Range Data Message Format

Speed and range data downloaded in 20/20 mode has the following general format:

speed, range <CR><LF>

where:

speed

is the speed measurement. Legal values are 000 to 199, preceded by a minus sign if the target was departing when the measurement was taken.

range

is the range measurement. Legal values are 0000.0 to 9999.9, unsigned.

<CR><LF>

is a carriage return/line feed.

Note that this format has no units indicators. The values are in the units in effect when the measurement was taken.

If a measurement error occurs, the speed and range values are replaced by an error code in the form **E**xx, where xx is the error code. See “Error Conditions” for the error code values.

Example Speed/Range Messages

English units:

50,700.0

Metric Units:

80,213.4