

STALKER

DUAL and DUAL SL

Moving Police Radar



Operator's Manual

applied concepts, inc.

2609 Technology Drive
Plano, TX 75074
Phone (972) 398-3780
Fax (972) 398-3781

Toll Free Sales 1-800-STALKER
Toll Free Service 1-877-STALKER
sales@a-concepts.com
www.stalkerradar.com

011-0065-00

TABLE OF CONTENTS

TABLE OF CONTENTS	1
INTRODUCTION.....	4
INSTALLATION.....	4
THEORY OF OPERATION	5
NON-SWITCH DISPLAY OPERATION	6
Display Front Panel	6
Display Unit Functions	6
Audible Indicators	7
ERGONOMIC REMOTE CONTROL FUNCTIONS	8
SWITCH DISPLAY OPERATION	10
SWITCH DISPLAY INSTALLATION.....	10
SWITCH DISPLAY FUNCTIONS	12
Switch Display Front Panel	12
Switch Display Switches	12
Switch Display Indicators.....	14
Audible Indicators	14
Sealed Remote Control Functions	15
Mini-IR Remote Control Functions.....	15
OPERATING THE STALKER DUAL.....	16
Stationary Mode Speed Measurement	16
Opposite Lane Moving Mode Speed Measurement.....	16
Same Lane Moving Mode Speed Measurement	17
Patrol Speed Shadowing Effect	17
Low-End Patrol Speed Selection	18
Range (Sensitivity) Adjustment.....	18
Doppler Audio	19
Beep Tones	19
Display Lighting.....	19
Patrol Speed Blanking	20
Software Version	20
Transmitter Frequency	20
STOPWATCH MODE.....	21
Stopwatch Theory	21
Stopwatch Mode Keys.....	22
Stopwatch Mode Errors	22
Stopwatch Mode Operation	22
Exit Stopwatch Mode	22
FASTER SPEED TRACKING THEORY	23
SAME LANE THEORY	24
Same Lane Operation (Stalker Dual SL only)	24
Doppler Signal Processing.....	24
Same Lane Examples.....	25
INTERFERENCE SOURCES AND REMEDIES	26
Terrain	26
Rain.....	26
Electrical Noise.....	26
Vehicle Ignition Noise.....	26
Fan Noise	26
Interference From Other Transmitters	27
Power Supply	27
No Power	27
TESTING	27
Periodic Calibration	27

Power-On Self-Test	27
Internal Circuit-Test.....	28
Automatic Self-Test.....	28
Moving-Vehicle Test	28
VEHICLE SPEED SENSOR (VSS) OPERATION	29
Traffic Radar Patrol Speed Measurement.....	29
The VSS Speedometer Signal.....	29
The Result is PERFECT Patrol Speed.....	29
VSS Cable Installation.....	29
Automatic VSS Calibration	29
First Time Calibration (or Installing the Radar in a New Vehicle)	30
Automatic Moving / Stationary Selection	30
Low Speed Speedometer Problems	30
LEGAL REQUIREMENTS	31
FCC Requirements.....	31
Case Law	31
MICROWAVE RADIATION.....	32
STALKER DUAL EMISSIONS	33
REQUIRED MAINTENANCE.....	33
TROUBLESHOOTING	33
STALKER DUAL MOUNTING OPTIONS	34
STALKER DUAL OPTIONS	36
WARRANTY	36

Dear Valued Radar Customer:

Thank you for choosing the ***STALKER DUAL*** Radar System. We sincerely appreciate you purchasing the ***STALKER DUAL*** and giving us the opportunity of serving you and your department. You will find the ***STALKER DUAL*** to be an invaluable tool in controlling speed violators and making your streets and highways safer. Most importantly, we care about you, our customer, and want you to be completely satisfied. Our success as a company depends upon your satisfaction and experience with the ***STALKER DUAL*** Radar.

Applied Concepts, Inc. believes that the ***STALKER DUAL*** offers more than superior performance and versatility. ***STALKER DUAL*** is backed 100% with reliable, professional, and experienced sales and service support, ready to assist you at your request. We also offer the longest warranty in the industry, with nationwide factory authorized repair centers to assure you of fast and efficient service.

We wish you the greatest success in your speed enforcement program. Please do not hesitate to let us know if there is anything we may do to add to your product satisfaction. Thanks again!

Sincerely,

Applied Concepts, Inc.

STALKER DUAL DSR is covered by one or more of the following United States Patents:
5,563,603 5,570,093 5,525,996 5,565,871 5,528,245 5,691,724 6,198,427
6,501,418

In addition, other United States Patents are pending.

©2004 Applied Concepts, Inc.

INTRODUCTION

STALKER DUAL is a Ka-Band speed-measuring radar that can be mounted in a variety of ways, and is operational with one or two antennas. Utilizing a state-of-the-art Digital Signal Processor (DSP), **STALKER DUAL** provides a level of performance, convenience, and accuracy previously unavailable. The DSP performs the critical filtering and timing functions required for speed measurement in its software, as opposed to its hardware. This provides less unit-to-unit variation, more reliable performance, and easier maintenance. The unique feature of the **STALKER DUAL** is that it can be upgraded in the future by simply reprogramming the flash memory chip, preventing obsolescence!

STALKER DUAL operates in Ka-Band from 33.4 to 36.0 GHz and provides a hold mode. Both Ka-Band operation and the hold feature reduce the possibility of detection by radar detectors. Target-speed locking, Track-thru-Lock speed, Faster Speed Tracking, and the Doppler audio capability assist the operator in positive target identification and provide operating convenience.

INSTALLATION

STALKER DUAL consists of a dash-mounted display unit; a counting unit that can be mounted with the display unit, or separately using the optional Remote Cabling Kit (P.N.200-0247-00); one or two antenna units; and a wireless/wired remote control unit. **STALKER DUAL** is powered from the 12-volt vehicle power system using a Power Cable from the counting unit. Each system component should be installed in a location that provides good operator visibility and convenience, but does not obscure the road or interfere with air bag operation. The Ka-Band antenna units are fully waterproof and can be installed outside the vehicle, if desired. The display, remote, and counting units are not waterproof and must be installed in a location sheltered from the weather. However, a waterproof Switch Display and waterproof hand controller are available for motorcycle installations. Longer cables are available from the factory for specific installations, if needed.

Display/Counting Unit - To mount the combined display/counting units, connect the Power Cable to the power jack on the back of the counting unit. Plug the front and/or rear antenna cables into the back of the counting unit. If using only one antenna, plug it into the front jack. After attaching the mounting bracket to the selected mounting surface with Velcro or screws, insert the combined display/counting unit into the mount and secure with thumbscrews (provided) into the threaded holes located on each side of the counting unit.

Display Unit - To mount the display unit only, separate the counting unit from the display unit by unscrewing the two screws on the back panel. Connect the 15-pin cable, supplied in the Remote Cabling Kit, to the connector on the back of the display unit. Attach the display unit to the mounting bracket using one thumbscrew on each side or attach directly to the dash. After mounting, make sure the display will not dislodge during high speed maneuvers.

Counting Unit - To mount the counting unit separately from the display unit, select an out-of-the-way mounting location, such as under the dash or under the front seat. Connect the Power Cable to the power jack located on the back of the counting unit. Plug the front and/or rear antenna cables into the back of the counting unit. If using only one antenna, plug it into the front jack. Connect the 15-pin cable, supplied in the Remote Cabling Kit, to the connector on the front of the counting unit. Secure the mounting bracket on the counting unit to a suitable mounting surface with Velcro or screws. Install the counting unit into the bracket using a thumbscrew on each side.

Antenna Unit - The radar can consist of either one or two Ka-Band antennas. *Before proceeding with the final installation, check the intended mounting locations for fan interference on both antennas. See the section on fan interference, page 26.* Find a suitable location and attach the antenna mounting bracket to the selected mounting surface. Attach the antenna unit to the bracket. Connect the antenna cable to the antenna. Repeat these steps for the second antenna, if desired.

Cordless Ergonomic Remote Control - The *only* installation required for the ergonomic remote control is to install the 3V Lithium battery (type 123). Remove the battery compartment cover by pressing down on the battery cover latch and rotating the battery cover away from the case. Install the battery, paying attention to the polarity markings. Replace the battery cover until it snaps in place. Velcro may be applied to the back of the remote control unit to attach it to the dash or other locations. Also, a microphone lug (supplied) can be attached to the back of the ergonomic remote control to allow installation into a microphone holder. An optional lanyard is also available. This remote control can be used in a wired mode. The Remote Control can be operated in wired mode by connecting a standard RJ-11 modular telephone handset cord (P.N. 155-2213-00 or Radio Shack #279-312). The cord is connected to the remote and radar unit, and battery removed for wired operation.

THEORY OF OPERATION

Stationary Mode - *STALKER DUAL* uses the Doppler frequency shift technique to measure the speed of moving vehicles. This technique is based on the Doppler Theory, which states that a radar signal reflected from a moving target will experience a frequency shift that is proportional to the speed of the target relative to the radar. Circuitry in ***STALKER DUAL*** processes the reflected signal to obtain the frequency shift. The Digital Signal Processor (DSP) then measures the frequency shift to obtain the target speed. In stationary mode, the transmitted signal strikes a moving target and is reflected back to the antenna. ***STALKER DUAL*** processes the signal to obtain the target speed. Targets, both approaching and receding, generate the same Doppler frequency shift; therefore, targets traveling both directions can be measured.

Opposite Lane Moving Mode - In opposite lane moving mode, two (2) signals must be processed to determine target speed. The first signal, patrol speed, results from the radar signal reflecting from passing stationary objects. Since the Doppler shift is proportional to the relative velocity between the radar and the passing reflecting objects, the Doppler shift of this signal will be proportional to the speed of the patrol vehicle. The second signal, closing speed, results from the radar signal reflecting from an approaching or retreating opposite lane moving target and then returning to the patrol vehicle. The Doppler shift of this signal will be proportional to the sum of the patrol speed and target speed, or closing speed. To determine the target speed, ***STALKER DUAL*** subtracts the patrol speed from the closing speed.

Same Lane Moving Mode - In same lane moving mode, two (2) signals must be processed to determine target speed. The first signal, patrol speed, results from the radar signal reflecting from passing stationary objects. Since the Doppler shift is proportional to the relative velocity between the radar and the passing reflecting objects, the Doppler shift of this signal will be proportional to the speed of the patrol vehicle.

The second signal, difference speed, results from the radar signal reflecting from an approaching or retreating same lane moving target and then returning to the patrol vehicle. The Doppler shift of this signal will be proportional to the difference speed between the patrol and target vehicles. If the target vehicle is moving faster than the patrol vehicle, the difference speed will be added to patrol speed to obtain target speed. If the target vehicle is moving slower than the patrol vehicle, the difference speed will be subtracted from the patrol speed to obtain target speed. For more detailed information, see the section on SAME LANE THEORY, page 24. The Same Lane feature is an option. *Your radar will not have this feature unless ordered.*

Faster Mode - *STALKER DUAL* offers a new feature called *Faster Speed Tracking*. *Faster* is a field selectable feature and can be easily disabled, if desired.

The addition of the *faster* mode allows, for the first time, the ability to track small high speed targets that normally could not be tracked because a stronger target shields the weaker target from normal speed measurement. The classic example is where a speeding sports car passes a slower moving eighteen wheeler: The *faster* sports car, although clearly speeding, previously could not be measured because the strongest truck target captures the target display window. ***STALKER DUAL SL***, in this example, will display the speed of the strongest truck in the target window, while the speed of the *faster* sports car will appear in the middle *faster* window. Tracking of both targets may be performed simultaneously. (See page 21.)

NON-SWITCH DISPLAY OPERATION

Display Front Panel

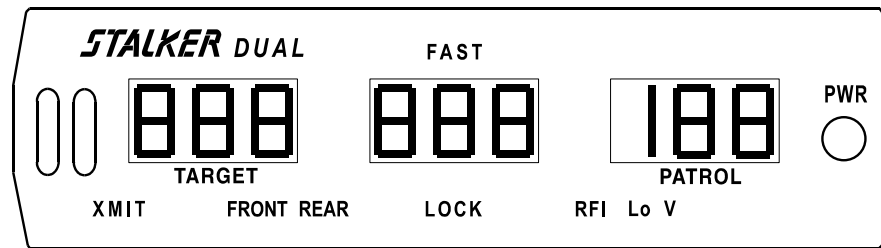

Fig 1

Display Unit Functions

- PWR:** The **PWR** switch is the main On/Off power switch. *STALKER DUAL* has a jumper in its power-supply circuit that selects one of the two following options:
1. When vehicle power is applied, the unit must be turned on by pressing the **PWR** switch. This is the normal factory setting.
 2. When vehicle power is applied, the unit always powers on automatically, but may be turned off by pressing the **PWR** switch. If this setting is desired, call the factory.
- TARGET WINDOW:** The left, three-digit LED window is the target window. This window displays the speed of targets entering the radar beam. While in stationary mode, the target window will show the speed of the strongest approaching or the strongest receding target relative to the radar. In opposite lane moving mode, the target window will show the speed of the strongest opposite lane approaching target or the strongest opposite lane receding target. In same lane moving mode (if this option was ordered), the target window will show the speed of the strongest same lane faster (front or rear) target or the strongest same lane slower (front or rear) target. See SAME LANE THEORY, page 24.
- MIDDLE WINDOW:** The middle, three-digit LED window is a dual purpose window. First, it is used for locking the strongest target shown in the left window. In addition, the middle window is used to display the *faster* target in the radar beam. The **LOCK** and **FAST** icons are used to indicate the current use of the window.
- The middle window is used to store target speeds that the operator chooses to "lock" using the **LOCK/REL** key. The presence of the **LOCK** icon indicates that the middle window contains a "locked" target speed.
- When the *faster* mode is selected and when no **LOCK** target is present, the middle window is used to track the *faster* target in the radar beam. *Faster* mode is turned on and off by alternately pressing the **FASTEST/SLOWER** key. The presence of the **FAST** icon indicates that the *faster* mode is selected.
- PATROL WINDOW:** The right, three-digit LED window is the patrol window. In moving mode, the operator should always verify that the patrol window is tracking the patrol vehicle's speedometer. After locking a target speed, the patrol window may be "blanked" by pressing the **PS BLANK** key. Restore the patrol speed by pressing the **PS BLANK** key a second time.
- XMIT:** The **XMIT** icon indicates that *STALKER DUAL* is transmitting on the currently selected antenna.

FRONT:	The FRONT icon indicates the front antenna is selected for use. The icon will light with a steady indication if the antenna is operational, or a blinking indication if the antenna is missing or inoperative.
REAR:	The REAR icon indicates the rear antenna is selected for use. The icon will light with a steady indication if the antenna is operational, or a blinking indication if the antenna is missing or inoperative.
SLOW:	The SLOW icon indicates that the radar is in <i>slow target</i> same lane mode. Conversely, <i>fast target</i> same lane mode is indicated by the absence of the SLOW icon. See SAME LANE THEORY, page 24. (Only available on units ordered with the Same Lane Option.)
SAME:	The SAME icon indicates that the radar is in same lane mode. Conversely, opposite lane mode is indicated by the absence of the SAME icon. See SAME LANE THEORY, page 24. (Only available on units ordered with the Same Lane Option.)
LOCK:	The LOCK icon indicates that the operator has locked a target speed in the center window.
RFI:	The RFI icon indicates the presence of an interfering signal. Operation is inhibited during an RFI indication.
Lo V:	The Lo V icon illuminates when the input voltage falls below 8.0 volts. Operation is inhibited while this icon is displayed, but normal operation will resume automatically when the input voltage is restored to a normal voltage (> 9.0 volts).

Audible Indicators

Antenna tones - Different audio tones are used when switching between the front and the rear antenna. A 1-beep tone corresponds to the front antenna, while a 2-beep tone corresponds to the rear antenna.

Faster tone - Different audio tones are used when turning the *faster* mode on and off. A high-pitched beep tone (for fast) indicates that *faster* mode is selected. A normal beep tone indicates that *faster* mode is turned off.

Self-Test tones - A 4-beep “happy” tone indicates the successful completion of a self-test operation. A 15-beep tone indicates a failed self-test.

Automatic Self-Test - An automatic self-test (indicated by a 4-beep “happy” tone) is performed every 10 minutes while **STALKER DUAL** is transmitting. Switching antennas will reset the 10-minute timer.

NOTE: If for any reason “FAIL” comes up on your **STALKER DUAL** Radar, the unit must be turned OFF and then back ON to reset the FAIL mode. As an example, if you did not properly attach the antenna cable and the word “FAIL” appeared, it would be necessary to correct this problem, to properly connect the cable, then turn the power OFF and then back ON. The word FAIL should not reappear.

ERGONOMIC REMOTE CONTROL FUNCTIONS



Fig 2

The ergonomic remote control shown above is the standard control supplied with the **STALKER DUAL** radar unit. It works with units ordered with or without the Same Lane option. Other optional remotes with a different cases and key configurations are shown on later pages.

LOCK/REL or STOPWATCH MODE:

This dual-function key controls both the Radar Mode function **STRONG LOCK/REL** and **STOPWATCH MODE** initiation.

LOCK/REL:

In Radar Mode, the **LOCK/REL** key alternates between target lock and release functions. The first time the **LOCK/REL** key is pressed, with a speed in the target window, that strong target speed is transferred to the middle window and locked along with the present patrol speed. This state is indicated by the illumination of the **LOCK** icon. Pressing **LOCK/REL** a second time clears the locked contents of both the lock and the patrol windows.

During lock, the **LOCK** icon will light. The target window and Doppler audio remain active after locking.

STOPWATCH MODE:	Hold down the STOPWATCH MODE key for 2 seconds to toggle the radar between Radar Mode and Stopwatch Mode. The display changes when the key is pressed, indicating the mode of operation.
MOV STA:	The MOVING/STATIONARY key toggles between moving and stationary modes. A speed or a [] in the patrol window indicates moving mode, while a blank patrol window indicates stationary mode. While operating in VSS mode (see section titled “VSS OPTION” on Page 29) the radar uses the presence (or absence) of VSS pulses to automatically switch between moving mode and stationary mode.
SAME/OPP:	The SAME/OPPOSITE key is used to alternate between same lane moving mode and opposite lane moving mode. The SAME icon toggles on and off to indicate same lane mode. (Same Lane option must be present in the Radar unit.)
ANT:	The ANT key is used to switch between the front and rear antennas, unless the radar was factory set for only one antenna. The FRONT or REAR icon will light. The display unit can sense the presence or absence of the front or rear antenna. A steady icon indicates an operational antenna and cable, while a blinking icon indicates a missing antenna and/or cable, or a malfunction of the antenna unit.
XMIT/HLD or S/S:	
XMIT/HLD:	The XMIT/HLD key toggles between XMIT (transmit) and HLD (standby). The XMIT icon will light for transmitting and extinguish for hold.
S/S:	When in Stopwatch Mode, the S/S key is used to start and stop the electronic timing of the target vehicle as it enters and exits the speed measurement zone.
FASTEST: (opposite lane and stationary)	In opposite lane and stationary modes, the FASTEST key is used to select <i>faster</i> mode. A high-pitched beep tone (for fast) indicates that <i>faster</i> mode is selected. A normal beep tone indicates that faster mode is turned off. Any power off event will reset the <i>faster</i> mode to OFF. Pressing the FASTEST key will again enable it. When the <i>faster</i> mode is selected and when no LOCK target is present, the middle window is used to track the <i>faster</i> target in the radar beam. <i>Faster</i> mode is turned on and off by alternately pressing the FASTEST key. The presence of the FAST icon indicates that the <i>faster</i> mode is selected.. The default condition for faster mode is OFF. Any power off event will reset the <i>faster</i> mode to OFF. Pressing the FASTEST key will again enable it.
SLOWER (same lane):	In same lane mode, the SLOWER key is used to toggle between <i>fast target</i> same lane mode and <i>slow target</i> same lane mode. See SAME LANE THEORY section, page 24.
SEn:	The SEn key is used to adjust the range up or down at any time. Maximum range (sensitivity) is SEn 4 , minimum range (sensitivity) is SEn 1 . The range (or sensitivity) must be set separately for same lane moving mode and opposite lane moving mode. While in <u>each</u> mode, (same lane and opposite lane/stationary), indicated by the presence or absence of the SAME icon, set each sensitivity as described above.
SQL:	The SQL key toggles the squelch override on and off. In the normal position (squelch on), audio will be heard only when a target is being tracked.
PS 5/20:	The PS 5/20 key is used to select one of the two selections for low end patrol speed of either 5 or 20 mph. For example: a patrol window indication of 20 starts tracking patrol speed at 20 mph, while a patrol window indication of 5 starts tracking patrol speed at 5 mph. If the VSS feature is enabled (see section titled “VSS OPTION” on Page 29), the PS 5/20 key will only display SP when pressed.
SELF TEST:	The SELF TEST key performs a diagnostic check on the display/counting unit and antenna. The display/counting unit will complete a display segment test, processor check, and crystal check, followed by the display of speeds of 10, 35, and 65; and ending with a display of the display/counting unit internal operating temperature in degrees Fahrenheit (e.g., 110 °F) (if the unit has been ordered in kilometers, the temperature will be displayed in Celsius (e.g., 35 °C)), and input battery voltage (e.g., bAt 13.8). A comprehensive test is also performed on the selected antenna by the counting unit to ensure the integrity of the antenna cable and antenna electronics. PASS or FAIL is indicated on the display unit after all tests have been completed.

(((▶) (Target Doppler)

The (((▶) key is used to adjust the volume of the Target Doppler audio up or down. Press the (((▶) key to make the display step through: **Aud 0**, **Aud 1**, **Aud 2**, **Aud 3**, and **Aud 4**. **Aud 0** is off and **Aud 4** is the loudest.

(((▶) (Beep Tones)

The (((▶) key is used in conjunction with **PS BLANK** key to adjust the volume of the beep tones. Press the (((▶) key followed by the **PS BLANK** key to make the display step through: **b 0**, **b 1**, **b 2**, and **b 3**. **b 0** is off and **b 3** is loudest. The Patrol Speed window will display the beep volume level.

PS BLANK:

This is a dual function key. If the patrol window indicates an incorrect patrol speed, the **PS BLANK** key blanks the patrol speed window and acquires a new patrol speed. The **PS BLANK** key also blanks the patrol speed after the target speed and patrol speed are locked. Press **PS BLANK** again to restore the blanked speeds.

LIGHT

This is a dual-function key. With a single depression, the **LIGHT** key activates the remote control keyboard back light for six (6) seconds. Two rapid depressions of the **LIGHT** key activate the display unit's brightness control. Additional depressions of the **LIGHT** key toggle the display intensity through six levels of brightness, ranging from **bri 1** (low) to **bri 6** (high). In the switched display only, an automatic brightness compensation setting of **bri A** will appear in the sequence of manual brightness settings.

SWITCH DISPLAY OPERATION

The plug-in switch display unit and the waterproof switch display unit are designed for use with the **STALKER DUAL** or **STALKER DUAL SL**. With these two accessory displays, our engineers have added switches to the front panel for operator convenience, increased the brightness level of the LEDs for operation in direct sunlight, provided for automatic LED brightness adjustment, and backlit the keys for night operation.

Plug-In Switch Display Unit - The plug-in switch display unit is designed for in-car use where front panel switches are desired for providing redundancy with the switches on the remote control. The plug-in switch display unit is also useful when it is desired to separately mount the display and counting unit to eliminate interference with airbags!

Normally the plug-in switch display unit plugs directly into the front of the counting unit via a connector just like the standard display unit. The plug-in switch display unit can be mounted either attached to the counting unit or separately from the counting unit using the optional remote cabling kit (P.N. 200-0247-00).

Waterproof Switch Display Unit - The waterproof switch display unit plugs into the counting unit via a cable mounted connector. The waterproof switch display unit was designed to give greater flexibility to your **STALKER DUAL** mounting options. Since the waterproof switch display unit is completely waterproof, it can be used along with the waterproof antenna and the sealed remote (described later in the manual) to provide motorcycle speed monitoring in any weather without the risk of damaging your radar unit!

SWITCH DISPLAY INSTALLATION

The radar consists of a display unit; a counting unit that is mounted separately from the display unit; one or two antenna units; and either an infrared cordless remote, a corded remote or a sealed waterproof remote control. The sealed remote control is recommended for use with the waterproof switch display unit.

Plug-In Switch Display Unit - To mount the combined plug-in switch display/counting units, connect the power cable to the power jack on the back of the counting unit. Plug the front and/or rear antenna cables into the back of the counting unit. If using only one antenna, plug it into the front jack. After attaching the mounting bracket to the selected mounting surface with Velcro or screws, insert the combined plug-in switch display/counting unit into the mount and secure with thumbscrews (provided) into the threaded holes located on each side of the counting unit. To mount the plug-in switch display unit only, separate the counting unit from the plug-in switch display unit by unscrewing the two screws on the back panel. Connect the 15-pin cable, supplied in the remote cabling kit (P.N. 200-0247-00), to the connector on the back of the plug-in switch display unit and to the connector on the front of the counting unit. Attach the plug-in switch display unit to its mounting bracket. After mounting, make sure the mount will not dislodge during high speed maneuvers.

Waterproof Switch Display Unit - Attach the waterproof switch display unit to the motorcycle using #6-32 screws and the waterproof switch display unit mounting bracket. The waterproof switch display unit can be provided with the cable exiting either the left or right side of its housing. Connect the 15-pin cable to the connector on the front of the counting unit. After mounting, make sure the unit and mount will not dislodge during high speed maneuvers.

Counting Unit - The counting unit is not waterproof, therefore, you should mount the counting unit in an out-of-the-weather location, such as the saddle bag. Connect the cable from the display unit to the counting unit. Plug the front and/or rear antenna cables into the back of the counting unit. If using only one antenna, plug it into the front jack. Plug the power cord from the counting unit into the cigarette-plug receptacle.

Antenna Unit - Find a suitable location and attach the antenna mounting bracket to the selected mounting surface. Attach the Antenna unit to the bracket. Connect the antenna cable to the antenna. Repeat these steps with the second antenna, if desired.

Remote Control - Follow the instructions below for your particular remote:

1. Infrared Remote - the only installation for any of the infrared remote controls is to install either the Lithium battery or 2 AA batteries, depending on model. Remove the battery compartment cover by sliding it away from the case. Install the two batteries, paying attention to the polarity markings. Replace the battery cover by sliding it onto the case until it snaps into place.
2. Corded Remote - attach the corded remote control to the counting unit using the power cord with a serial port
3. Sealed Remote - attach the Sealed Remote control to the counting unit using the power cord with a serial port. See the figure below for a brief description of the Sealed Remote functions.

SWITCH DISPLAY FUNCTIONS

Switch Display Front Panel

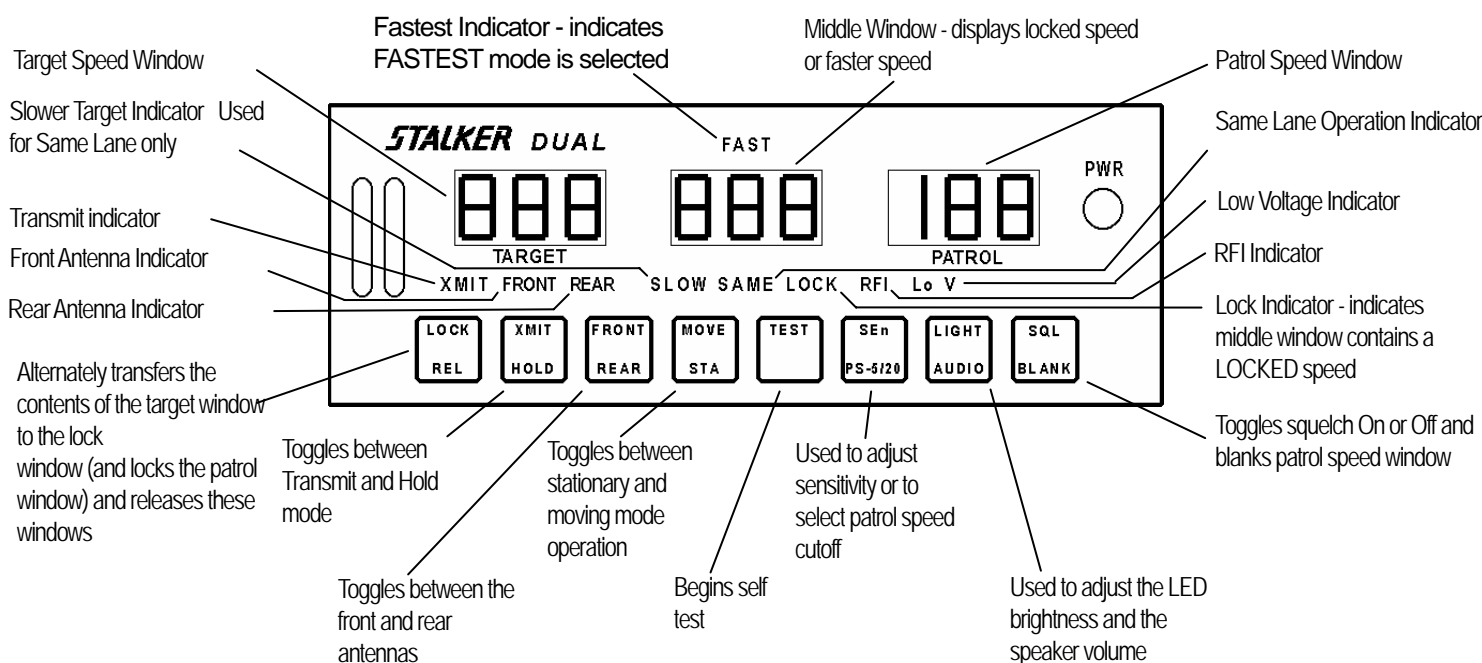

Switch Display Switches

PWR:

The **PWR** switch is the main On/Off power switch. **STALKER DUAL** and **STALKER DUAL SL** have a jumper in their power-supply circuit that selects one of the two following options:

1. When vehicle power is applied, the unit must be turned on by pressing the PWR switch. This is the normal factory setting.
2. When vehicle power is applied, the unit always powers on automatically, but may be turned off by pressing the PWR switch. If this setting is desired, call the factory.

LOCK/REL:

The **LOCK/REL** key is a dual function key. This key alternates between the lock and the release functions. **LOCK** is used to transfer the contents of the target window to the lock window. **REL** clears the locked contents of the lock window and the patrol window. During lock, the patrol window will lock the present patrol speed and the **LOCK** icon will light. The target window and Doppler audio remain active after locking.

XMIT/HOLD:

The **XMIT/HOLD** key toggles between xmit (transmit) and hold (standby). The **XMIT** icon will light for transmitting and extinguish for hold.

- FRONT/REAR:** The **FRONT/REAR** key is used to switch between the front and rear antenna, unless the radar was factory set for only one antenna. The **FRONT** or **REAR** icon will light. The display unit can sense the presence or absence of the front or rear antenna. A steady icon indicates an operational antenna and cable, while a blinking icon indicates a missing antenna and/or cable, or a malfunction of the antenna unit.
- MOVE/STA:** The **MOVE/STA** key toggles between moving and stationary modes. A speed or a [] in the patrol window indicates moving mode, while a blank patrol window indicates stationary mode. While operating in VSS mode (see section titled “VSS OPTION” on Page 29) the radar uses the presence (or absence) of VSS pulses to automatically switch between moving mode and stationary mode.
- TEST:** The **TEST** key performs a diagnostic check on the display/counting unit and antenna. The display/counting unit will first complete a processor check, memory check, and crystal check; followed by the display of speeds of 10, 35, and 65; and ending with a display of the display/counting unit internal operating temperature in degrees Fahrenheit (e.g., 110 °F) (if the unit has been ordered in kilometers, the temperature will be displayed in Celsius (e.g., 35 °C)), and input battery voltage (e.g., bAt 13.8). A comprehensive test is also performed on the selected antenna by the display/counting unit to ensure the integrity of the antenna cable and antenna electronics. **PASS** or **FAIL** is indicated on the display unit after all tests have been completed.
- SEn/P.S. 5/20:** This is a dual function key. The **SEn/P.S. 5/20** key is used to adjust the sensitivity (range) and the patrol speed threshold simultaneously. With each press, this key will cycle through the following eight sensitivity and patrol speed threshold levels: SEn 1 5, SEn 1 20, SEn 2 5, SEn 2 20, SEn 3 5, SEn 3 20, SEn 4 5, and SEn 4 20. The first number is the sensitivity or range - for example, maximum sensitivity would be indicated by **SEn 4**, and minimum sensitivity as **SEn 1**. The sensitivity must be set for same lane moving mode and opposite lane moving mode separately. While in each mode (same lane and opposite lane), indicated by the presence or absence of the **SAME** icon, set each sensitivity as described above. The second number (when the VSS feature is not enabled) is the low end patrol speed of either **5** mph or **20** mph. For example: a patrol window indication of **20** starts tracking patrol speed at 20 mph, while a patrol window indication of **5** starts tracking patrol speed at 5 mph. If the VSS feature is enabled, an **SP** will displayed along with the sensitivity setting.
- LIGHT/AUDIO:** This is a dual function key. The **LIGHT/AUDIO** key toggles between the light brightness and the audio modes. Press and hold the key until the display indicates the desired mode.
- LED brightness can be either manually set (by selecting 1 of 6 levels) or automatically set (by selecting auto). Once in the current brightness mode (e.g., **bri 4**), press the **LIGHT/AUDIO** key rapidly to cycle the unit through the six levels of brightness intensity and auto position, ranging from **bri 1** (low) to **bri 6** (high) to **bri A**. The auto brightness function is selected with the **bri A** position.
- Once in the current audio mode (e.g., **Aud 2**), press the **LIGHT/AUDIO** key rapidly to cycle the unit through the four levels of volume ranging from **Aud 0** (silent) to **Aud 4** (loudest).
- The **LIGHT/AUDIO** key is used in conjunction with **SQL/BLANK** key to adjust the volume of the beep tones. Once in the current audio mode, press the **SQL/BLANK** key to make the display step through: **b 0**, **b 1**, **b 2**, and **b 3**. **b 0** is off and **b 3** is loudest. The Patrol Speed window will display the beep volume level.
- SQL/BLANK:** This is a dual function key. If the patrol window indicates an incorrect patrol speed, one *rapid* depression of the **BLANK** key blanks the patrol speed window and acquires a new patrol speed. The **BLANK** key also blanks the patrol speed after the target speed and patrol speed are locked. Press **BLANK** again to restore the blanked speeds.
- To toggle the squelch override, press and hold the **SQL/BLANK** key until either **On** or **OFF** is displayed. In the **On** position, audio will be heard only when a target is being tracked.

Switch Display Indicators

TARGET WINDOW:	The left, three-digit LED window is the target window. This window displays the speed of targets entering the radar beam. While in stationary mode, the target window will show the speed of the <u>strongest</u> approaching or the <u>strongest</u> receding target relative to the radar. In opposite lane moving mode, the target window will show the speed of the <u>strongest</u> opposite lane approaching target or the <u>strongest</u> opposite lane receding target. In same lane moving mode, the target window will show the speed of the <u>strongest</u> same lane faster (front or rear) target or the <u>strongest</u> same lane slower (front or rear) target.
MIDDLE WINDOW:	<p>The middle, three-digit LED window is a <u>dual purpose</u> window. First, it is used for locking the <u>strongest</u> target shown in the left window. In addition, the middle window is used to display the <i>faster</i> target in the radar beam. The LOCK and FAST icons are used to indicate the current use of the window.</p> <p>The middle window is used to store target speeds that the operator chooses to "lock" using the LOCK key. The presence of the LOCK icon indicates that the middle window contains a "locked" target speed.</p> <p>When the <i>faster</i> mode is selected and when no LOCK target is present, the middle window is used to track the <i>faster</i> target in the radar beam. <i>Faster</i> mode is turned on and off by alternately pressing the FASTEST key. The presence of the FAST icon indicates that the middle window contains a <i>faster</i> target speed. The default condition for <i>faster</i> mode is OFF. Any power-off event will reset the <i>faster</i> mode to OFF. Press the FASTEST key again to enable it.</p>
PATROL WINDOW:	The right, three-digit LED window is the patrol window. In moving mode, the operator <u>must</u> verify that the patrol window is tracking the patrol vehicle's speedometer. After locking a target speed, the patrol window may be "blanked" by pressing the BLANK key. Restore the patrol speed by pressing the BLANK key a second time.
XMIT:	The XMIT icon indicates that STALKER DUAL or STALKER DUAL SL is transmitting.
FRONT:	The FRONT icon indicates the front antenna is selected for use. The icon will light with a steady indication if the antenna is operational, or a blinking indication if the antenna is missing or inoperative.
REAR:	The REAR icon indicates the rear antenna is selected for use. The icon will light with a steady indication if the antenna is operational, or a blinking indication if the antenna is missing or inoperative.
SLOW:	The SLOW icon indicates that the radar is in <i>slow target</i> same lane mode. Conversely, <i>fast target</i> same lane mode is indicated by the absence of the SLOW icon
SAME:	The SAME icon indicates that the radar is in same lane mode. Conversely, opposite lane mode is indicated by the absence of the SAME icon.
LOCK:	The LOCK icon indicates that the operator has locked a target speed in the center window.
RFI:	The RFI icon indicates the presence of an interfering signal. Operation is inhibited during an RFI indication.
Lo V:	The Lo V icon illuminates when the input voltage falls below 9.0 volts. Operation is inhibited while this icon is displayed, but normal operation will resume automatically when the input voltage is restored to a normal voltage.

Audible Indicators

Antenna tones - Different audio tones are used when switching between the front and rear antenna. A 1-beep tone corresponds to the front antenna, while a 2-beep tone corresponds to the rear antenna.

Faster tone - Different audio tones are used when turning the *faster* mode on and off. A high pitched beep tone (for fast) indicates that *faster* mode is selected. A normal beep tone indicates that *faster* mode is turned off. Any power off event will reset the *faster* mode to OFF. Pressing the **FASTEST** key will again enable it.

Self-Test tones - A 4-beep “happy” tone indicates the successful completion of a self-test operation. A 15-beep tone indicates a failed self-test.

Automatic Self-Test - An automatic self-test (indicated by a 4-beep “happy” tone) is performed every 10 minutes while **STALKER DUAL** or **STALKER DUAL SL** is transmitting. Switching antennas will reset the 10 minute timer.

Sealed Remote Control Functions

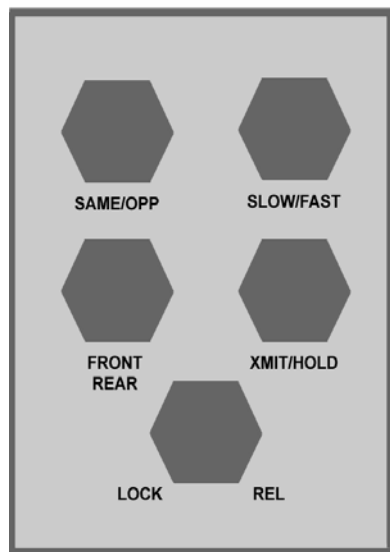

Fig. 4

SAME/OPP - toggles between same lane moving mode and opposite lane moving mode. The **SAME** icon toggles On and Off to indicate same lane mode.

SLOW/FAST - in opposite and stationary modes, the **SLOW/FAST** key is used to select *faster* mode. In same lane mode, the key is used to toggle between *fast target* same lane mode and *slow target* same lane mode.

FRONT/REAR - used to switch between the front and rear antenna, unless the radar is factory set for only one antenna. The appropriate **FRONT** or **REAR** icon will light on the display unit

XMIT/HOLD - toggles between xmit (transmit) and hold (standby). The **XMIT** icon will light for transmitting and extinguish for hold.

LOCK/REL - this key alternates between the lock and the release functions.

Mini-IR Remote Control Functions

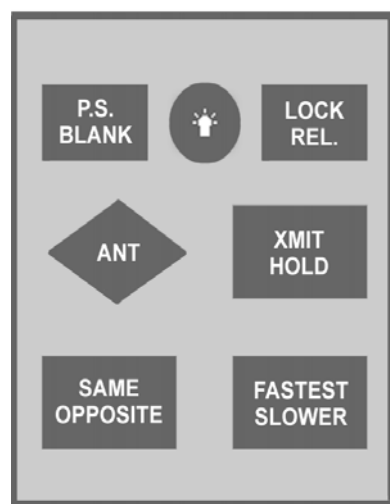

Fig. 5

P.S. BLANK: - This is a dual function key. If the patrol window indicates an incorrect patrol speed, the **P.S. BLANK** key blanks the patrol speed window and acquires a new patrol speed. The **P.S. BLANK** key also blanks the patrol speed after the target speed and patrol speed are locked. Press **P.S. BLANK** again to restore the blanked speeds.

- This is a dual function key. With a single depression, the key activates the keyboard backlight for six (6) seconds. Two rapid depressions of the key activate the display unit’s brightness control. Additional depressions of the key toggle the display intensity through six levels of brightness, ranging from **bri 1** (low) to **bri 6** (high).

LOCK/REL. - The **LOCK/REL.** key is a dual function key. This key alternates between the lock and the release functions. **LOCK** is used to transfer the contents of the target window to the lock window. **REL.** clears the locked contents of the lock window and the patrol window. During lock, the patrol window will lock the present patrol speed and the **LOCK** icon will light. The target window and Doppler audio remain active after locking.

ANT - The **ANT** key is used to switch between the front and rear antenna, unless the radar was factory set for only one antenna. The **FRONT** or **REAR** icon will light. The display unit can sense the presence or absence of the front or rear antenna. A steady icon indicates an operational antenna and cable, while a blinking icon indicates a missing antenna and/or cable, or a malfunction of the antenna unit.

XMIT/HOLD - The **XMIT/HOLD** key toggles between xmit (transmit) and hold (standby). The **XMIT** icon will light for transmitting and extinguish for hold.

SAME/OPP - The **SAME/OPP** key is used to alternate between same lane moving mode and opposite lane moving mode. The **SAME** icon toggles on and off to indicate same lane mode.

FASTER (opposite lane and stationary) - In opposite lane and stationary modes, the **FASTEST** key is used to select *faster* mode. A high pitched beep tone (for fast) indicates that *faster* mode is selected. A normal beep tone indicates that *faster* mode is turned off. Any power off event will reset the *faster* mode to OFF. Pressing the **FASTEST** key will again enable it.

When the *faster* mode is selected and when no **LOCK** target is present, the middle window is used to track the *faster* target in the radar beam. *Faster* mode is turned on and off by alternately pressing the **FASTEST** key. The presence of the **FAST** icon indicates that the *faster* mode is selected. The default condition for *faster* mode is OFF. Any power off event will reset the *faster* mode to OFF. Pressing the **FASTEST** key will again enable it.

SLOWER (same lane) - In same lane mode, the **SLOWER** key is used to toggle between *fast target* same lane mode and *slow target* same lane mode. See SAME LANE THEORY section, page 24.

OPERATING THE STALKER DUAL

Stationary Mode Speed Measurement

Select stationary mode by pressing the **MOV/STA** key on the remote control, then select the desired antenna by pressing the **ANT** key. To transmit, press the **XMIT/HOLD** key. The **XMIT** icon should appear on the display unit (Fig 6) indicating that a radar signal is being transmitted.

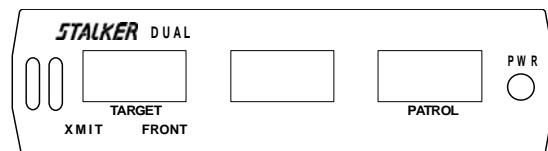

Fig 6

If a target is in range, such as one traveling 54 mph, the speed will appear in the target window of the display unit (Fig 7); and a Doppler audio tone, which is proportional to the target speed, will be heard from the speaker. The target speed is continually measured and displayed, and the Doppler audio tone is heard as long as the target is present.

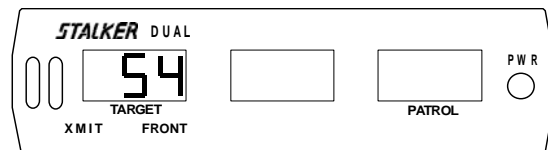

Fig 7

Hold mode can be selected by pressing the **XMIT/HOLD** key on the remote control. In hold mode, The **XMIT** icon will be off (Fig 8) and no signal will be transmitted, preventing detection by radar detectors.

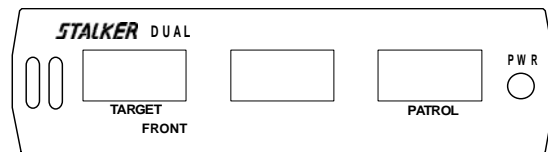

Fig 8

NOTE: While operating in VSS mode (see section titled "VSS OPTION" on Page 29) the radar uses the presence (or absence) of VSS pulses to automatically switch between moving mode and stationary mode.

Opposite Lane Moving Mode Speed Measurement

Select moving mode by pressing the **MOV/STA** key on the remote control. When **STALKER DUAL** is in moving mode, the patrol window will contain either the patrol speed or a []. The [] (Fig 9) indicates that **STALKER DUAL** is in moving mode, but has no ground speed. Select opposite lane mode by pressing the **SAME/OPP** key until the **SAME** icon is not visible. To transmit, press the **XMIT/HOLD** key. The **XMIT** icon should appear on the display unit (Fig 9) indicating that a radar signal is being transmitted. Be sure the patrol speed

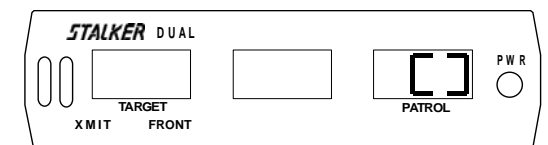

Fig 9

indicated corresponds to the speedometer of the patrol vehicle. If an approaching target is in the radar beam, its speed will appear in the target window and a Doppler audio tone will be heard from the speaker. Fig 10 is an example in which the patrol speed is 50 and the approaching target speed is 68. The target speed is continually measured and displayed and the Doppler audio tone is heard while the **STALKER DUAL** is in transmit mode and a target is present.

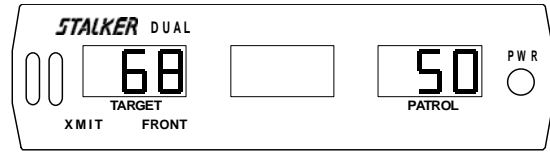

Fig 10

Hold mode can be selected by pressing the **XMIT/HOLD** key on the remote control. In hold mode, the **XMIT** icon will be off (Fig 11) and no signal will be transmitted. This prevents detection by radar detectors. When in hold, **STALKER DUAL** remembers the last patrol speed and looks for that speed first when changing from hold back to transmit.

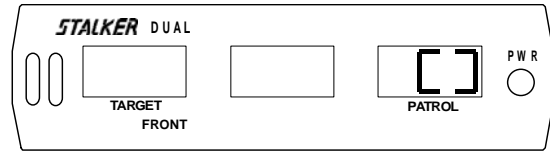

Fig 11

NOTE: While operating in VSS mode (see section titled “VSS OPTION” on Page 29) the radar uses the presence (or absence) of VSS pulses to automatically switch between moving mode and stationary mode.

Same Lane Moving Mode Speed Measurement

(Stalker Dual SL only.)

Patrol speed is especially important while operating in the same lane moving mode. The patrol vehicle should be traveling *slower or faster* than all targets in the radar beam. Normally, traveling slower than all same lane targets is recommended.

To transmit, press the **XMIT/HOLD** key. Select same lane moving mode by pressing the **MOV/STA** key, then select same lane mode by pressing the **SAME/OPP** key. Same lane mode is selected when the **SAME** icon is visible (Fig 12). Note: When Same Lane is selected, the sensitivity is automatically reduced internally by software. A sensitivity setting of 4 is recommended in Same Lane.

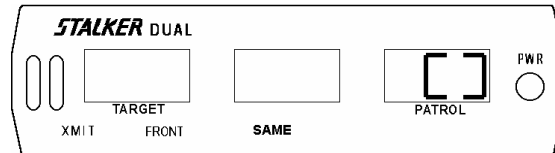

Fig 12

If a same lane target is in the radar beam, its speed will appear in the target window and the difference speed audio will be heard from the speaker. The target speed is obtained by adding the difference speed to the patrol speed. Fig 13 is an example of a patrol speed of 50 and a faster same lane target in front of the patrol vehicle traveling at 68. The target speed is continually measured and displayed and the Doppler audio tone is heard while the **STALKER DUAL SL** is in transmit mode and a target is present.

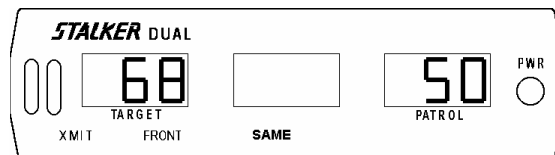

Fig 13

For targets in the radar beam that are traveling slower than the patrol vehicle, it is necessary to press the **SLOWER** key. Fig 14 is an example of a patrol speed of 50 and a slower same lane target in front of the patrol vehicle traveling at 48.

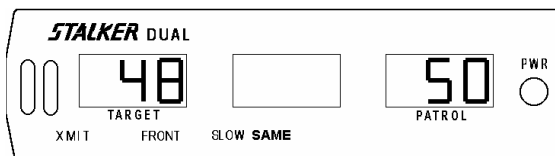

Fig 14

*NOTE: To verify that the **SLOWER** key is in the right position, change the speed of the patrol vehicle by 2 - 3 mph, observing that the displayed target speed does not change.*

Patrol Speed Shadowing Effect

Traditional radar units exclude patrol speed lock-on and tracking below 20 mph. One of the unique features of **STALKER DUAL** is that it allows patrol speed lock-on and tracking below 5 mph, when the low-end patrol speed is set to 5. This feature is very popular and is excellent for enforcing school zones. However, with this setting, **STALKER DUAL** is more prone to "shadowing." Shadowing occurs when a strong same lane target in the radar beam captures the patrol speed, instead of the weaker passing ground reflection.

The following is an example of the shadowing effect: A patrol vehicle traveling 30 mph is following a pickup traveling 42 mph. The pickup is pulling away from the patrol vehicle at 12 mph. The radar, in error, thinks this 12 mph speed is the correct ground speed and displays 12 mph in the patrol window, instead of the correct value of 30 mph.

STALKER DUAL has three options for eliminating the shadowing effect: (1) make the unit re-acquire the correct patrol speed by pressing the **PS BLANK** key, (2) change the low-end patrol speed from 5 mph to 20 mph (see following paragraph for instructions), and (3) operate the radar using the optional VSS mode. To eliminate the shadowing effect in the city, option (1) is recommended. Option (2) is recommended for highway radar use. Option 3 eliminates all shadowing and is achieved by installation of VSS cabling in the patrol vehicle.

Low-End Patrol Speed Selection

The **PS 5/20** key is used to set the low-end patrol speed. The right two digits of the patrol window refer to the current low-end patrol speed of either 5 mph or 20 mph. For example, sensitivity 1 with 5 mph low-end patrol speed would be indicated by: **SEn 1 5** (Fig 15). Sensitivity 1 with 20 mph low-end patrol speed would be: **SEn 1 20** (Fig 16). During VSS operation this function is not required and thus is not available. During VSS operation, when the **PS 5/20** key is pressed, SP will be momentarily displayed.

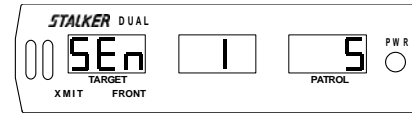

Fig 15

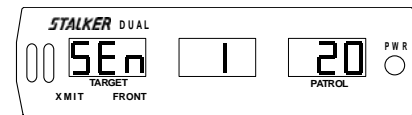

Fig 16

Range (Sensitivity) Adjustment

The range (or sensitivity) of **STALKER DUAL** is adjusted by pressing the **SEn** key. This key cycles through the four (4) sensitivity levels; **SEn 1**, **SEn 2**, **SEn 3**, and **SEn 4** (Fig 17 - Fig 20, respectively). In each case, the center display refers to the current sensitivity setting. The shortest range is **SEn 1** (Fig 17), and the longest range is **SEn 4** (Fig 20). The range (or sensitivity) must be set for same lane moving mode and opposite lane moving/stationary mode separately. While in each mode, (same lane and opposite lane), indicated by the presence or absence of the **SAME** icon, set each sensitivity as described above.

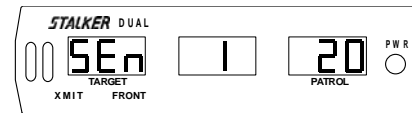

Fig 17

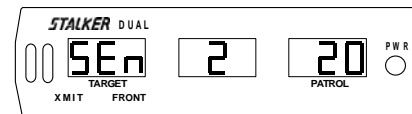

Fig 18

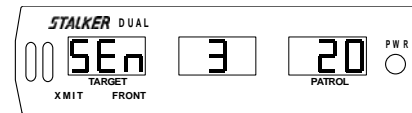

Fig 19

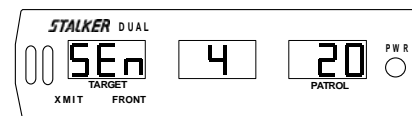



Fig 20



Doppler Audio

When a target is being tracked, a Doppler audio tone can be heard from the speaker. The pitch of this tone is a precise indication of target speed. The tone quality is useful for judging possible interfering or multiple targets.





In opposite lane moving mode, *STALKER DUAL* compensates for patrol speed variations when generating the Doppler audio. Since the audio tones do not vary with patrol speed, the operator soon learns to correlate the Doppler audio with the target speed. This eliminates the need of constantly watching the display to determine target speed. In same lane moving mode, *STALKER DUAL* generates difference audio instead of the true audio described above. The difference audio gives a direct indication of the difference in speed between the patrol vehicle and the target vehicle.

The speaker volume can be adjusted through five levels by pressing the  key on the remote control. Maximum audio volume is indicated by **Aud 4** (Fig 21), and audio off (an optional factory setting) is indicated by **Aud 0**(Fig 22).

Beep Tones

The  key is used in conjunction with **PS BLANK** key to adjust the beep tones. Press  key followed by **PS BLANK** to make the display step through: **b 0**, **b 1**, **b 2**, and **b 3**. **b 0** is off and **b 3** (Fig 23) is loudest.

Display Lighting

The display unit can be adjusted for brightness by using the  key. A single depression of the  key activates the keyboard backlight for 6 seconds. Two rapid depressions of the  key activate the display unit's brightness control, and additional depressions of the  key toggle the display intensity through six levels of brightness, ranging from low (**bri 1**) to high (**bri 6**) (Fig 24). The switched display has an automatic brightness setting (**bri A**).

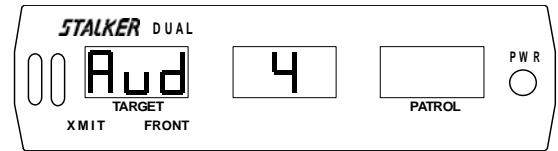

Fig 21

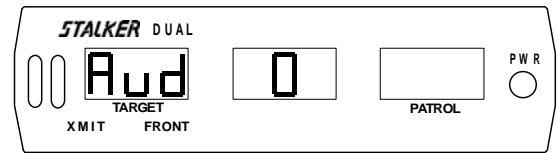

Fig 22

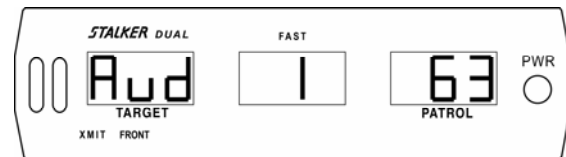

Fig 23

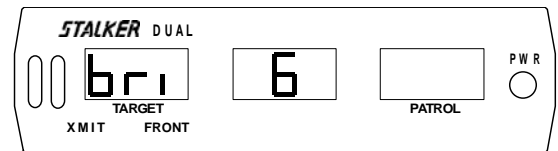

Fig 24

Patrol Speed Blanking

After locking a target and patrol speed (Fig 25), the patrol speed window may be "blanked" by pressing the **PS BLANK** key (Fig 26). The patrol speed can be restored by pressing the **PS BLANK** key a second time. When the lock window is not occupied by a "locked" target speed, the **PS BLANK** key is used to blank the patrol window and re-acquire patrol speed.

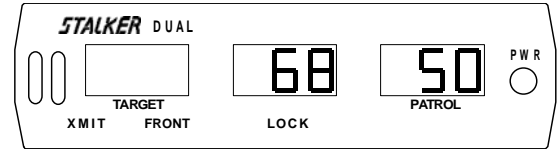

Fig 25

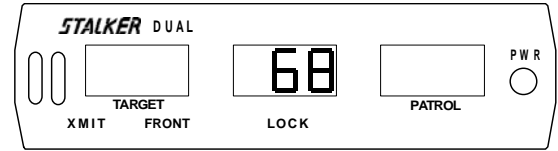

Fig 26

Software Version

While all segments are illuminated following power up (Fig 39) press the **SELF TEST** key to display the installed software version. Figure 27 indicates that software version 42 is installed. Check with the factory for the availability of an updated software version, if desired.

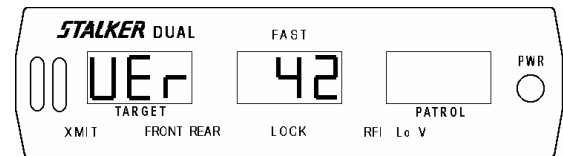

Fig 27

Transmitter Frequency

Immediately after the software version is shown (Fig 27), the transmitter frequency is displayed. Figure 28 indicates a transmitter frequency of 34.7 GHz. Ka-Band. Figure 29 indicates a transmitter frequency of 0, meaning no antenna is connected.

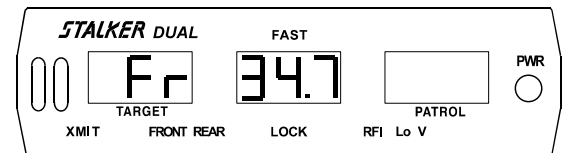

Fig 28

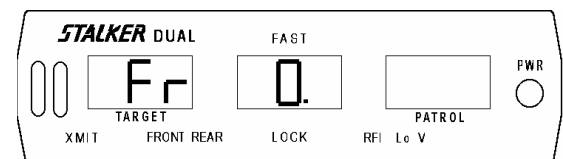

Fig 29

STOPWATCH MODE

STALKER DUAL offers Stopwatch mode. Stopwatch mode is used to measure target speeds using the traditional time-distance method. All of the timing and computing is performed in the **STALKER DUAL** counting unit. The length (in yards) of the measurement zone must first be entered into the counting unit using the remote control keys. The maximum length of the measurement zone is 999 yards.

Since the electronic timer is started (by pressing **S/S**) when the target vehicle enters the measurement zone and stopped when the target vehicle exits the measurement zone, the time to traverse the measurement zone is measured and stored in the counting unit. After the completion of each start/stop timing interval, the counting unit displays the calculated target speed in the patrol window.

NOTE: IT IS REQUIRED THAT THE ANTENNA BE CONNECTED DURING STOPWATCH MODE. THE COUNTING UNIT USES THE ANTENNA INTERNAL CRYSTAL FOR START/STOP TIMING DURING STOPWATCH MODE.

Stopwatch Theory

The counting unit calculates speed by measuring how much time it takes the vehicle to pass through the pre-set distance and then calculates and displays the speed in MPH or KPH. The known distance is divided by the measured time and multiplied by a conversion factor to obtain target speed.

Example: 1/2 mile (880 yards) of distance over 30 seconds of time = 60 mph
 1/4 mile (440 yards) of distance over 15 seconds of time = 60 mph
 1/4 mile (440 yards) of distance over 11.9 seconds of time = 75 mph

The speed (mph) formula is: mph = 2.045 x $\frac{\text{Distance (in yards)}}{\text{Time (in seconds)}}$

To easily convert yard/sec into mph, there is a 2.045 conversion factor that is used. Multiplying yards/sec by the 2.045 conversion factor will provide speed in miles per hour.

No hard and fast rule can be established concerning the minimum distance over which a vehicle should be monitored. However, several factors enter into the equation which does establish the fact, that the farther the distance, the less the chance of impact of an error. Three factors that can influence the calculation include:

1. Human error in activating the **START/STOP (S/S)** key
2. The distance measured
3. The speed of the vehicle

Human error can occur by the operator not pressing the **S/S** key at the precise time that the vehicle enters and exits the measurement zone.

If too short of distance is entered, it increases the chance for error. We recommend a minimum of 220 yards.

The greater the speed, the longer the measurement distance should be to reduce the possibility of an error. For example, if you are mostly measuring high speeds you should measure using a longer distance than if measuring slow speeds.

Stopwatch Mode Keys

On the optional remote control, all of the blue lettering on the keys corresponds to Stopwatch mode. The standard ergonomic remote control does not use the blue key format.

To enter or exit Stopwatch mode, using the ergonomic remote, press and hold the **STOPWATCH MODE** key for two seconds. The **STOPWATCH MODE** key toggles the radar between Radar mode and Stopwatch mode. The display changes when the **STOPWATCH MODE** key is pressed indicating the operating mode. Fig 30 shows a typical display following entry into Stopwatch mode. The 440 yards display will normally be a different number – depending upon its previous setting.

The **100**, **10**, and **1** keys are used to change the length of the measurement zone.

The **S/S** key is used to start and stop the timing interval of the target vehicle traversing the measurement zone.

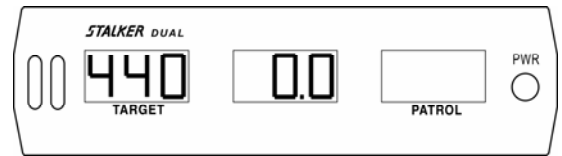

Fig 30

Stopwatch Mode Errors

If you get a **FAIL** message or an **Err** message (Fig 31) while trying to operate in Stopwatch mode, verify that the Antenna is properly connected and functioning. The counting unit uses the antenna internal crystal for start/stop timing during Stopwatch mode. At the end of each timing interval the antenna internal crystal is compared against the counting unit crystal within a small tolerance. If a crystal error is detected, the **Err** message is displayed.

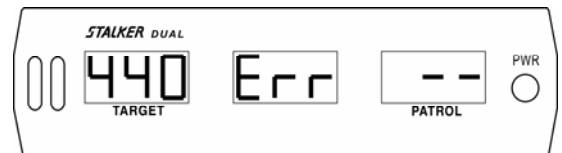

Fig 31

Stopwatch Mode Operation

1. Enter Stopwatch mode using the ergonomic remote control by pressing and holding the **STOPWATCH MODE** key for two seconds (Fig 32).
2. Enter the measurement zone distance using the **100**, **10**, and **1** keys.
3. While observing the target vehicle traverse the measurement zone, start timing by pressing the **S/S** key once upon entry and stop timing by pressing the **S/S** key again upon exit.
4. The Computed speed will be computed and shown in the patrol window. Fig 28 is an example of a 440 yard measurement zone, a 11.9 second measurement interval, and a 75 mph computed speed.

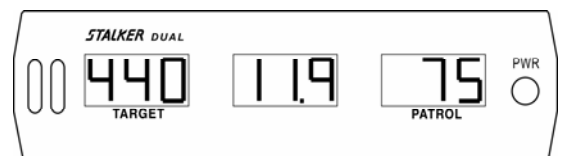

Fig 32

Exit Stopwatch Mode

To exit Stopwatch mode, press the **STOPWATCH MODE** key. The **STALKER DUAL** will reset and revert to Radar mode again.

FASTER SPEED TRACKING THEORY

The following examples are *Faster* targets under various conditions. The *Faster* mode has to be toggled "ON" by pressing the **FASTEST** key. The key does not have to be held or depressed. In addition to the speeds displayed in each window, carefully note the icons illuminated.

The addition of the *Faster* mode allows **STALKER DUAL** to track a smaller high-speed target that was previously undetectable because a stronger target shielded the weaker (smaller) target from normal speed measurement. The classic example is where a speeding sports car passes a slower moving eighteen wheeler. The *Faster* sports car, although clearly speeding, could not be measured because the strongest truck target captured the target display window. **STALKER DUAL** with *Faster* capability, however, will display the speed of the strongest target (the truck) in the target window, while the speed of the *Faster* target (the sports car) will appear in the middle *Faster* window.

STALKER DUAL simultaneously tracks both targets: however, the target window is always reserved for the strongest target and the *Faster* window is reserved for the Faster target. When the *Faster* target becomes the strongest target, the *Faster* target's speed will transfer to the strongest target window. The *Faster* target's speed can be locked only when it becomes the strongest target. The result is better tracking for better court testimony! See the examples on the next page:

Moving Mode Example:

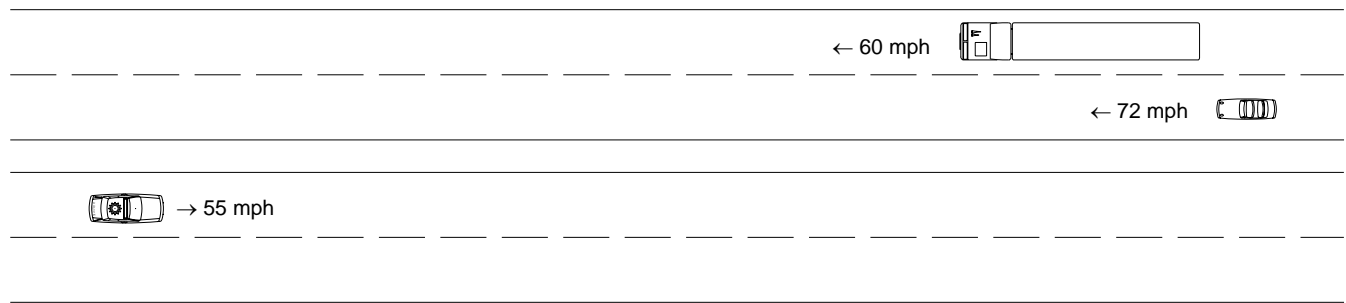

A Patrol vehicle is cruising at 55 mph. Two opposite lane targets are approaching from the front - a 60 mph truck and a 72 mph sports car behind the truck. The 60 mph strongest out-front target (the truck) appears in the target window and the 72 mph *Faster* target (the sports car) appears in the middle window (Fig 33). The *Faster* target cannot be locked unless it becomes the strongest target and appears in the left window.

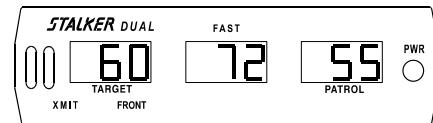

Fig 33

The 60 mph strongest target can be locked, by pressing the **LOCK** key (Fig 34). Note how the middle window changes from a *Faster* window to a Lock window. The **FAST** icon has been replaced by the **LOCK** icon. The middle window is therefore defined by the icon that is associated with it.

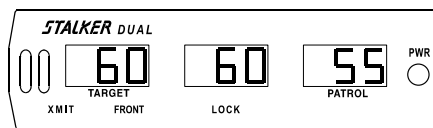
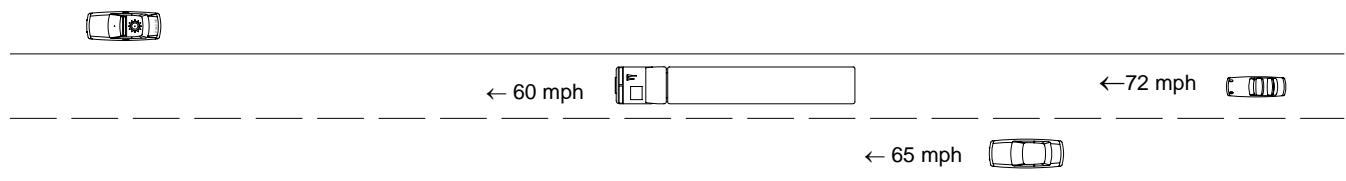

Fig 34

Stationary Mode Example:



A Patrol vehicle is parked at the top of a hill monitoring approaching traffic with his rear antenna. The first target, a 60 mph truck, is the strongest out-front target and appears in the target window (Fig 35). The third target, the 72 mph *Faster* sports car, is tracked in the middle *Faster* window. The *Faster* target can be locked by pressing the **LOCK** key when it becomes the strongest target.

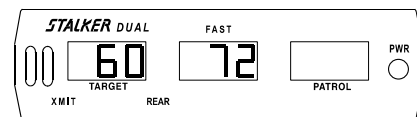

Fig 35

SAME LANE THEORY

Same Lane Operation (Stalker Dual SL only)

1. To transmit, press the **XMIT/HOLD** key. The **XMIT** icon should appear on the display indicating a radar signal is being transmitted.
2. Select moving mode by pressing the **MOV/STA** key on the remote control. When **STALKER DUAL SL** is in moving mode, the patrol window will contain either the patrol speed or a []. The [] indicates that **STALKER DUAL SL** is in moving mode, but has no ground speed. Be sure the patrol speed indicated corresponds to the speedometer of the patrol vehicle.
3. Then select same lane mode by pressing the **SAME/OPP** key. Same lane mode is selected when the **SAME** icon is visible.
4. If a target is in the radar beam, its speed will appear in the target window and a Doppler audio tone will be heard from the speaker.
5. Patrol speed is especially important while operating in the same lane moving mode. The patrol vehicle should be traveling *slower or faster* than **all** targets in the radar beam. Normally, traveling slower than all same lane targets is recommended. After visually estimating the speed of the targets in the radar beam, press the **SLOWER** key to correspond to whether the observed targets are traveling faster or slower than the patrol vehicle. The **SLOW** icon indicates that the *target* is traveling slower.
6. To verify that the **SLOWER** key is in the right position, change the speed of the patrol vehicle by 2-3 mph, observing that the displayed target speed does not change.

Doppler Signal Processing

Two signals must be processed to determine target speed. The first signal, patrol speed, results from the radar signal reflecting from passing stationary objects. The Doppler shift of this signal will be proportional to the speed of the patrol vehicle, since Doppler shift is proportional to the relative velocity between the radar and the passing reflecting objects.

The second signal, difference speed, results from the radar beam reflecting from a slower or faster same lane moving target and then returning to the patrol vehicle. The Doppler shift of this signal will be proportional to the difference speed between the patrol and target vehicles. The audio tones heard while in same lane mode are directly related to this difference speed.

The radar is unable to distinguish between a difference speed resulting from a faster or slower target. The operator must tell the radar how to process this signal by pressing the **SLOWER** key. If the target vehicle is moving faster than the patrol vehicle, the difference speed must be added to patrol speed to obtain target speed. If the target vehicle is moving slower than the patrol vehicle, the difference speed must be subtracted from the patrol speed to obtain target speed.

The operator selects either addition or subtraction by pressing the **SLOWER** key on the remote control while observing the **SLOW** icon on the display. When the **SLOW** icon is off, the counting unit adds the difference speed to the patrol speed to obtain target speed. When the **SLOW** icon is on, the counting unit subtracts the difference speed from the patrol speed to obtain target speed.

*NOTE: To verify that the **SLOWER** key is in the right position, change the speed of the patrol vehicle by 2 - 3 mph, observing that the displayed target speed does not change.*

Example

Patrol Speed = 55 mph

Difference Speed = 10 mph

For faster target:
Target = 55+10 = 65

For slower target:
Target = 55-10 = 45

For faster target:
SLOW icon is OFF

For slower target:
SLOW icon is ON

Same Lane Examples

The following examples are same lane targets under various conditions. In addition to speeds displayed in each window, carefully note the icons illuminated.

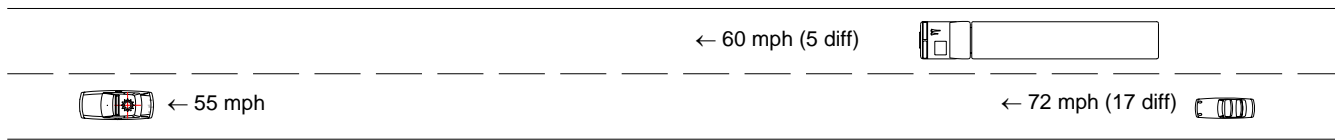

A Patrol vehicle is cruising at 55 mph.

Two *faster* same lane targets are approaching from behind. A 60 mph ($55+5=60$) truck and a 72 mph ($55+17=72$) sports car behind the truck. The strongest out-front target (the truck) appears in the target window (Fig 36).

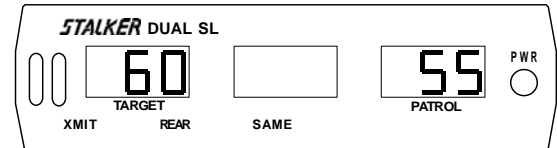

Fig 36

The 60 mph strongest target can be locked, by pressing the **LOCK/REL** key (Fig 37).

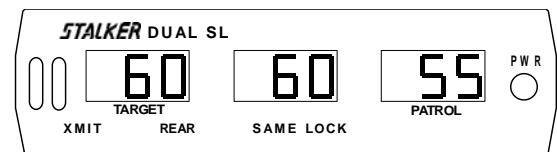
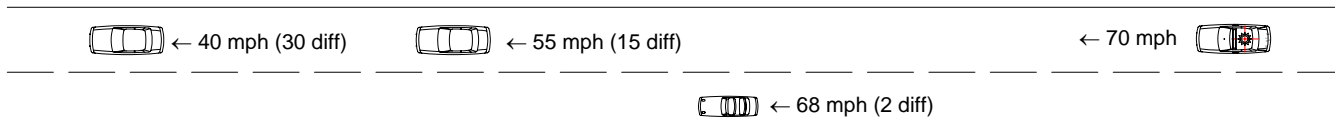

Fig 37



This is an example of pacing *slower* targets in same lane mode. Notice that the **SLOW** icon is visible in Fig 38. The 70 mph patrol vehicle is following the 68 mph ($70-2=68$) sports car. The 68 mph target (sports car) appears in the target window.

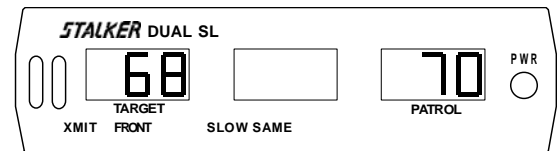
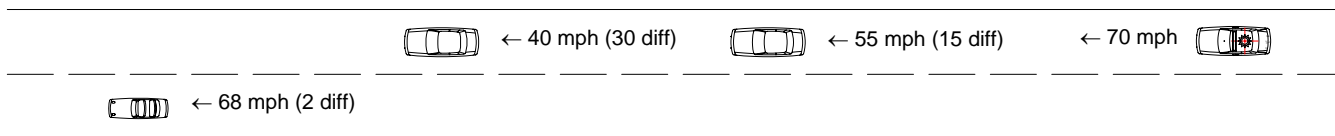

Fig 38



Once the 68 mph sports car passes the other two targets, it will be blocked out by them. The strongest 55 mph target is now in the target window as shown in Fig 39.

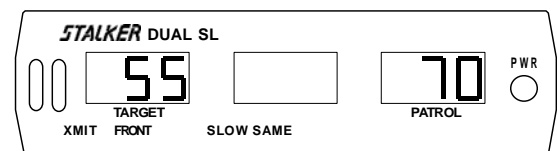

Fig 39

INTERFERENCE SOURCES AND REMEDIES

A variety of sources, both natural and man-made, can cause misleading indications or poor performance. The operator should note the symptoms described below, and take steps to avoid the problem, or ignore the misleading indications.

Terrain

Radar signals will not pass through most solid objects, including tree foliage. Make certain the path between the radar and target vehicle is unobstructed. A glass window is a partial reflector of radar; therefore, some reduction in range will be experienced when aiming through patrol vehicle windows.

Rain

Rain absorbs and scatters the radar signal. This reduces the range and increases the possibility of obtaining readings from the speed of the raindrops.

Electrical Noise

Electrical noise sources include neon signs, radio transmitters, power lines, and transformers. These influences may cause reduced range or intermittent readings. When these interferences are present, the RFI indicator should come on and suppress all readings.

Vehicle Ignition Noise

An extremely noisy vehicle electrical system may cause erratic operation. If this condition occurs, it is recommended that a two conductor shielded cable be run directly from the vehicle battery to the cigarette lighter plug on the dash. This should eliminate any problems from vehicle electrical noise.

Fan Noise

As you will discover, the *STALKER DUAL* that you have purchased is extremely sensitive resulting in longer range. This extra sensitivity may allow you to pick up fan noise when operating the radar from inside the patrol vehicle.

Fan noise is a common Doppler radar problem when aiming the antenna through a window from inside the patrol vehicle. A small amount of the radar beam is reflected off the glass back into the vehicle. This may allow the radar to pick up fan noise from within the patrol vehicle.

The problem is not a problem with the radar, but with the location of the radar's antenna. Doppler radar is designed to detect moving or vibrating objects; therefore, it may detect any moving or vibrating surfaces inside the patrol vehicle, such as the fan or a dashboard that is vibrating from the fan. Fan interference can be verified by turning off or changing the speed of the fan.

Most fans generate speeds of 30 mph or less. As a result, fan noise is normally only a problem when operating in stationary mode or when operating in moving mode with patrol speeds less than 30 mph.

To eliminate fan noise, try the following steps in numerical order:

1. Find a location (by moving the antenna) inside the vehicle that is free of fan noise; such as a corner of the dash away from the fan. The lower left side of the dash is a recommended location.
2. Insure that the antenna beam is not deflected back into the vehicle by anything in its path such as wipers, window trim, or anything mounted on the dash. Do not mount the counting/display unit or antenna/power cables in front of the antenna on the dash.
3. Locate the antenna as close to the inside glass as possible (preferably less than 1/2 inch).
4. Turn the fan off while operating the radar in stationary mode or moving mode with patrol speed under 30 mph.
5. Install an optional Antenna Port on the glass surfaces directly in front of the antenna. The specially designed Antenna Port consists of two white discs, 3 1/2 inches in diameter, with double-sided tape on one side. Attach one disc on the inside glass surface, and the other disc on the outside glass surface. Due to interference with windshield wipers, the Antenna Port can only be installed on the rear window.
6. If the above suggestions fail, mount the antenna completely outside the vehicle.

Interference From Other Transmitters

Strong signals from nearby radio transmitters may interfere with operation of **STALKER DUAL**. The **RFI** indicator (Fig 40) signals that an interference source has been detected. Speed readings are inhibited when this occurs to prevent the possibility of false readings. The interference source may be the vehicle's two-way radio, another nearby transmitter, or an illegal radar-jamming device.

Power Supply

A low voltage condition from the vehicle's electrical system will cause a **Lo V** indication (Fig 41), and will inhibit speed readings. An extremely noisy vehicle electrical system may result in false readings or erratic operation. If this condition occurs, a two-conductor, shielded cable should be connected directly from the vehicle battery to the cigarette-plug on the dash. This should eliminate any problems from vehicle electrical noise.

No Power

If you get no power to the unit, first check the fuse in your radar by unscrewing the silver contact tip at the bottom of the cigar plug and removing the fuse. Check the fuse to see if it has blown. If so, replace with a new fuse and try to locate the cause. If the fuse is *okay*, check the fuse to the *vehicle's* cigar plug. If this fuse is also okay, place the radar in a different vehicle or try a different radar in your vehicle.

TESTING

In order to ensure continued compliance with FCC rules, meet legal requirements for admissibility of radar speed measurements, and verify full operating performance, the following test procedures are recommended. If the unit fails any of the tests, it should be removed from service until the cause of the problem is corrected.

As Law Enforcement Radar technology has progressed, the need for tuning fork calibration has been eliminated. The only calibration currently required for the **STALKER DUAL** is the Power-On and the periodic automatic self-tests.

Periodic Calibration

We recommend that the following performance characteristics should be verified on a regular basis:

1. Transmitter frequency is within specification on licensed operating frequency.
2. Unit indicates correct speed (± 1 mph) when reading a target of known speed.
3. Unit detects targets of good reflectivity over unobstructed, flat terrain at distances of 1/2 mile, or more, when set for highest sensitivity (**SEn 4**).

Power-On Self-Test

Each time the unit is powered on, an automatic self-test is performed to verify that the unit functions. The display indicates 888 888 188 (Fig 42) during the test. A 4-beep "happy" tone indicates the successful completion of this test. If a problem is detected, FAIL will be displayed along with a 15-beep tone. Immediately after power-on, and while all display segments are illuminated, pressing the **SELF TEST** key will display the software version followed by the transmitter frequency (see page 20).

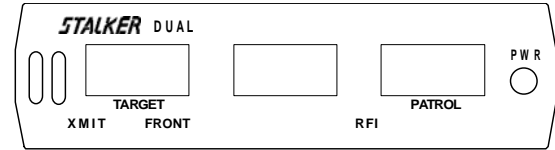

Fig 40

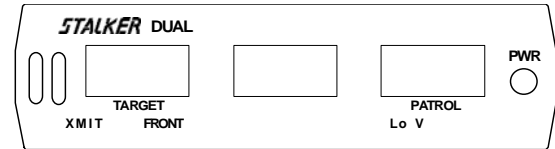

Fig 41

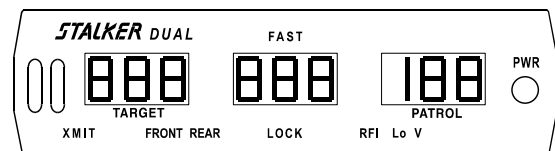

Fig 42

Internal Circuit-Test

An internal circuit test can be performed at any time by pressing the **SELF TEST** key. This performs a diagnostic check on the display/counting unit, the selected antenna, and antenna cable. Since only the selected antenna is tested, it is necessary to perform this test twice -- once with the front antenna selected, and once with the rear antenna selected.

The display/counting unit will first complete a processor check, memory check, and crystal accuracy check; followed by the display of speeds of **10**, **35**, and **65** (Figures 43, 44, and 45); and ending with a display of the display/counting unit internal operating temperature in degrees Fahrenheit (e.g., **110 °F**) (if the unit has been ordered in kilometers, the temperature will be displayed in Celsius (e.g., **35 °C**)), and input battery voltage (e.g., **bAt 13.8**) (Fig 46 and Fig 47, respectively).

A comprehensive test is also performed on the selected antenna by the display/counting unit to ensure the integrity of the selected antenna cable and antenna electronics. After all the tests are completed, **PASS** (Fig 48) along with a 4-beep “happy” tone indicate successful test completion. **FAIL** (Fig 49) along with a 15-beep tone indicates a failed self-test.

Note: *We recommend that the internal circuit test be performed on each antenna.*

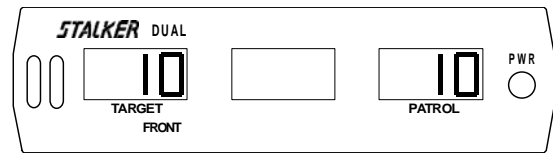

Fig 43

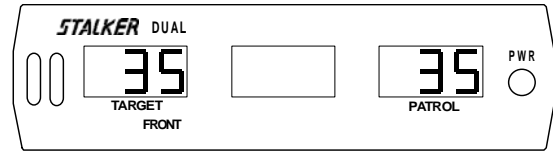

Fig 44

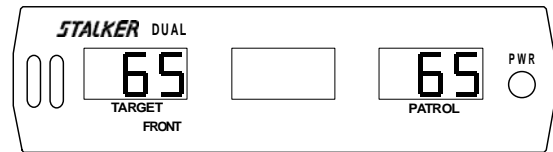

Fig 45

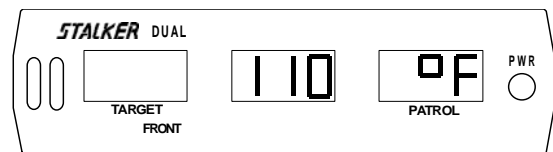

Fig 46

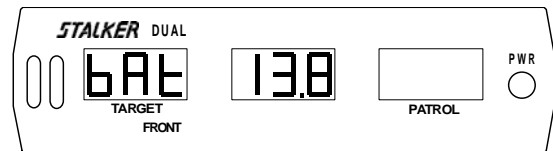

Fig 47

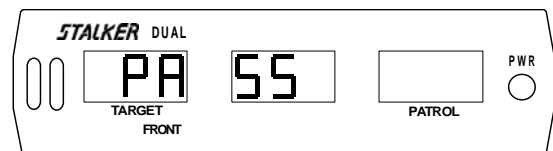

Fig 48

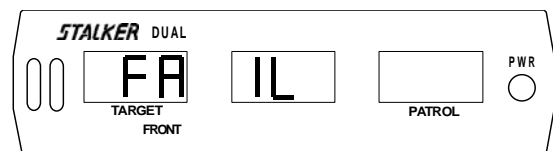

Fig 49

Automatic Self-Test

An automatic self-test (indicated by a 4-beep “happy” tone) is performed every 10 minutes while **STALKER DUAL** is transmitting. Switching antenna will reset the 10 minute timer.

Moving-Vehicle Test

A moving-vehicle test can be performed as an additional check of performance and accuracy. While driving a patrol vehicle, with an accurately calibrated speedometer, aim the antenna down an empty highway directly in front of the vehicle. The speed indicated by **STALKER DUAL** should match the speedometer indication to within a small error (depending on speedometer accuracy). This test is optional, and is a good overall indication of proper operation of the unit.

VEHICLE SPEED SENSOR (VSS) OPERATION

Traffic Radar Patrol Speed Measurement

Moving traffic radar systems normally obtain patrol speed by measuring the speed of the radar return from the moving roadway in front of the vehicle. Patrol speed tracking sometimes suffers from anomalies known as “batching” and “shadowing”. These anomalies occur during moments when the roadway is obstructed from the radar beam by road conditions or other vehicles. The solution is to allow the traffic radar to monitor vehicle tire rotation and to use this information to perform “patrol speed steering.” The simplest way to monitor tire rotation is to attach to the Vehicle Speed Sensor (VSS) signal in the patrol vehicle.

The VSS Speedometer Signal

All modern vehicles have a VSS sensor (Vehicle Speed Sensor) attached to the transmission or an axle that generates a speed signal. The speedometer and other electronics in the vehicle use the VSS speed signal. By tapping into this signal, the Stalker Dual DSR can monitor the actual patrol car speed and use the VSS speed information to help the radar pick the correct ground speed. The radar’s patrol car speed is still always measured by radar. The VSS simply helps steer the radar into making the right choice.

The Result is PERFECT Patrol Speed

- The radar will never shadow.
- It tracks and acquires patrol speeds from 1-200 mph.
- Moving / Stationary selection becomes automatic.

VSS Cable Installation

To take advantage of VSS patrol speed steering, requires two cables that are provided with the VSS Option.

The vehicle VSS cable (PN 155-2179-00), should be permanently installed by an automobile service shop using the included installation instructions.

On the right is how the vehicle VSS cable is normally attached (with 3 screws) to the bottom of the dash with a metal L-bracket for convenience.

The radar VSS cable (PN 155-2178-00) replaces the conventional cigarette power cable and can be removed from the vehicle with the radar.

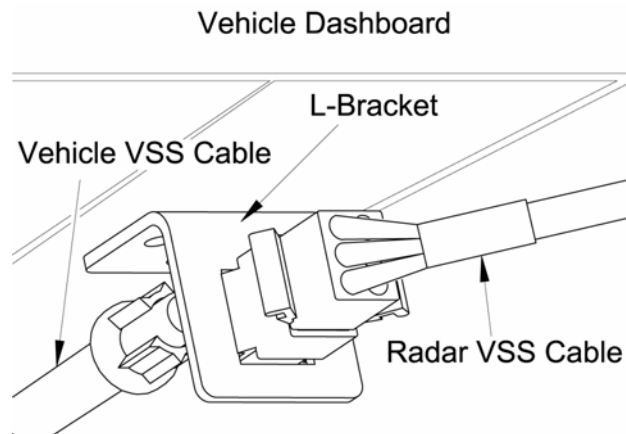

IMPORTANT NOTE: Observe the black polarity marks on the two white 6-pin VSS connectors that plug together. The two white 6-pin VSS connectors can be plugged together with the marks in alignment or the marks opposed. Because of vehicle VSS signal level variations, one of these plug-in positions may not provide a working VSS signal to the radar. If you observe the symptom of the speedometer not functioning or the symptom of the radar not “seeing” the VSS signal, rotate the marks 180° and try again.

Automatic VSS Calibration

Once the VSS cables are properly installed, the radar is ready to synchronize the vehicle’s VSS signal with the radar’s ground speed readings. The calibration sequence will determine the proper ratio between the VSS signal speed and the radar ground speed. The numeric result is stored in the radar’s memory (called a calibration factor).

Every time the radar is turned on and then operated, the auto-calibration routine is triggered. The very first time the radar is installed and operated, the auto-calibration sequence may take a few minutes (since there is not a previously stored

calibration factor to verify). During successive operations, in the same vehicle, the auto-calibration routine will seem instant.

First Time Calibration (or Installing the Radar in a New Vehicle)

To auto-calibrate you will need to operate (with the radar transmitting) in the moving mode for a few city blocks. The radar can complete the calibration sequence much faster if the speed of the vehicle is varied above 20 mph (don't merely drive at a steady speed at first). When you see the patrol speed window consistently showing an accurate speed, then the auto-calibration sequence has been successful. If, after several blocks of driving, the patrol speed display is either blank or incorrect, then unplug the 6 pin VSS cable connector, rotate it 180 degrees, power up the radar, and try again.

Automatic Moving / Stationary Selection

When the radar is receiving VSS signals, and it has been calibrated, the unit should automatically switch between moving and stationary operation modes when the patrol vehicle moves and stops. While moving, the **MOV/STA** key will not override the moving / stationary mode selected by the VSS steered radar.

Low Speed Speedometer Problems

In some vehicles, the VSS signal is non-existent at speeds below 5-10 mph so you may see no change in the car's speedometer reading until the car exceeds 10 mph. In these cases, the Stalker Dual radar will also not be switched into moving mode until the patrol car exceeds 10 mph.

LEGAL REQUIREMENTS

FCC Requirements

The Federal Communications Commission requires that all transmitting equipment carry a Grant of Type Acceptance. ***STALKER DUAL*** is Type Accepted by the FCC under Type Acceptance number IBQACMI002. The FCC also requires that an operating license be obtained by the user of the equipment. In the case of local government agencies already licensed under part 90 in the Public Safety Radio Service, the requirement for a separate authorization for radar speed detection devices was eliminated, effective February 1, 1983, and licensees may operate speed detection devices as part of their base/mobile communications systems. As part of this rule change, licensees are required to list the number of speed detection units, and the frequencies on which they operate upon renewal of their land mobile authorizations.

Case Law

Legal precedent has clearly established the accuracy, and admissibility of Doppler speed radar evidence. This section on case law is included so the radar operator can familiarize himself with the more important legal cases involving the use of Doppler speed radar, and be aware of the guidelines concerning admissibility established by these cases. Much of the referenced material may be obtained at your local law library or prosecutor's office.

Reference A -- State v. Dantonio (N.J.), 115 A2d 35, 49 ALR 2d 460 The landmark case on the use of traffic radar. This case sets precedent of the following:

1. Judicial notice has been taken of accuracy of radar.
2. A few hours training is sufficient to qualify an operator.
3. The operator need not understand or be able to explain internal workings of the radar.

Reference B -- Everight v. Little Rock, ARK., 326 SW2d 796: Establishes that the court may take judicial notice of the reliability of radar.

Reference C -- State v. Graham (Mo.), 322 SW2d 188: Establishes that the court may take judicial notice of the ability of radar to measure speed.

Reference D -- State v. Tomanelli (Conn.), 216 A2d 625: Reviews the matter of judicial notice; recognizes the ability of Doppler radar to measure the speed of a motor vehicle; and acknowledges that the tuning fork is a reliable accuracy test.

Reference E -- Honeycut v. Commonwealth (Ky.), 408 SW2d 421: In this appeal, the court rejects, one by one, the arguments of the appellant that the evidence should not have been admitted; and again establishes the following: (1) A properly constructed, and operated radar device is capable of measuring accurately the speed of a motor vehicle. (2) The tuning fork test is an accurate method of determining accuracy of the radar. (3) It is sufficient to qualify an operator that has such knowledge, and training that enables him to properly set up, test, and read the radar. (4) The operator is not required to understand the scientific principles of radar, nor explain its inner workings; in addition, the operator may be qualified to operate the radar after receiving a few hours of instruction. (5) The officer's estimate of excessive speed, from visual observation, when confirmed by the reading of the radar device and when the offending vehicle is out-front, by itself, nearest the unit, is sufficient to identify the vehicle, if the officer's visual observations support the radar evidence.

From the case law above, a successful prosecution may depend on the officer's ability to testify to the following points:

1. The qualifications and training of the officer.
2. The time, place and location of the radar device at the time the offense occurred.
3. The location of the offending vehicle at the time the offense occurred.
4. The identification of the offending person as the operator of the vehicle.
5. The identification of the offending person's vehicle.
6. The visual observation of its apparent, excessive speed.
7. The vehicle was out-front, by itself, nearest the radar when the reading was obtained.

MICROWAVE RADIATION

The following section has been supplied courtesy of the Food and Drug Administration (FDA).

UPDATE ON POSSIBLE HAZARDS OF TRAFFIC RADAR DEVICES

July 20, 1992

TO: CITY, COUNTY, STATE, AND FEDERAL POLICE OFFICIALS

Recent stories in the news media have focused attention on the possibility that the traffic radar devices used by police officers might increase their risk of cancer, particularly testicular cancer. The Food and Drug Administration (FDA) has prepared the following information to inform police officers about what is known--and what remains unknown--about this question. **We urge you to make this Update available to the officers under your jurisdiction. Feel free to photocopy this Update as needed.**

What kind of radiation is emitted by traffic radar units?

These devices emit microwave radiation similar to the type produced inside microwave ovens, but at a power level more than 10,000 times lower. The radiation travels from the front of the radar device in a narrow, cone-shaped beam, although some of it may be reflected back from hard surfaces such as metal and glass. The amount of radiation decreases rapidly with distance from the source, so that the farther the devices are kept from the body, the lower the exposure.

Is there any experimental evidence that the levels of microwave radiation from a traffic radar device can be dangerous?

Although it is known that very high levels of microwave radiation can be harmful, there is no firm experimental evidence at present that the much lower levels of radiation emitted by traffic radar devices can be hazardous. There are some animal studies that suggest that low levels of radar can cause biological changes, but it is not known whether these results apply to humans. Also, most of these studies were done with a different type of microwave radiation than that produced by traffic radar devices.

What about the cancers that have occurred in police officers who used traffic radar devices for long periods of time?

It is true that some officers who have used these devices have experienced cancer. But it is important to understand that these types of cancers also occur among people who **haven't** used radar devices. That's why it is not possible to tell whether any individual officer's cancer arose because of the radar, or whether it would have happened anyway. **The key question is whether the risk of getting a particular form of cancer is greater among people who work with the radar devices than among the rest of the population.** And the only way to answer that question is to compare the cancer rates among radar-using police officers with people who don't work with radar, or with the cancer rates that would be expected in the general population.

FDA has made a preliminary comparison between the number of cancers reported in police officers who use traffic radar devices and cancer rates in the general population. Based on case reports we have so far, the comparison does not appear to show a greater cancer rate among the police, but it is too soon to conclude that there is no risk.

What's FDA doing to address the question of cancer risk?

FDA will continue to evaluate the research performed by microwave scientists around the world to see if their results apply to traffic radar devices. In addition, FDA will work with police organizations to collect more data about the cancer experience of police officers, to see whether they are developing more than the expected number of cancers. To assist us in this effort, any known cases of cancer in police officers using radar should be reported to FDA by calling 1-800-638-6725. Be sure to provide as much information as possible, including the type of radar unit used, how long the individual worked with radar devices, and the specific type of cancer.

In the meantime, what can be done to reduce the risk, if there is one?

Although it is not known for sure whether traffic radar devices can produce health problems, police officers can take some simple steps which will sharply reduce their exposure to the low-level microwave radiation which these devices emit.

1. Always point the device away from your body, or your partner's body, while it is turned on.
2. Mount fixed radar antennas so that the beam is not pointed at any occupant of the patrol car.
3. Whenever possible, turn off a hand-held unit when it is not in use. If your unit has a "standby" mode, always use it when not measuring the speed of a vehicle. Never rest the unit against your body when it is turned on.
4. When it is on, try to avoid pointing the device toward metal surfaces inside your car, such as the floor or a door, to avoid microwave reflection. (Measurements have shown that the radiation reflected from nonmetallic surfaces, such as glass in the car's windows, is much less intense than that reflected from metal surfaces.)

Again, there is no proof at this point that traffic radar devices can be harmful to the police officers who use them. Future information may reveal that these devices are indeed harmless. But until the question is settled, taking the simple precautions outlined above should reduce any possible risk. In the meantime, FDA will continue to provide updates as more information becomes available.

STALKER DUAL EMISSIONS

The **STALKER DUAL** Radar operates with a nominal power output of 15 mw and a maximum of 50 mw of power output and emits low level, non-ionizing radio frequency electromagnetic radiation. The American National Standards Institute (ANSI) has the responsibility for establishing standards with respect to human exposure to radio frequency electromagnetic radiation. The current ANSI C95.1 standard in effect, for frequencies from 1500 MHz to 100,000 MHz, specifies a maximum exposure power density of 5.0 mw/cm² (.005 Watt/cm²) on any part of the body. The **STALKER DUAL** has a maximum power density of 2.0 mw/cm² that is well below the ANSI standard.

REQUIRED MAINTENANCE

No user maintenance is required on the **STALKER DUAL**. However, if any problems are experienced during testing procedures or normal operation, the unit should be taken immediately to your department's radar specialist to determine the extent of the problem. If a malfunction has occurred, the unit will require servicing. Normal care should be taken by the user in handling the **STALKER DUAL** to preserve the life and usefulness of the equipment.

TROUBLESHOOTING

PWR key does not function

Make sure all cables are mated correctly with their connectors. Check the vehicle cigarette-plug connector for dirty contacts. Check for a blown fuse in the **STALKER DUAL** cigarette-plug.

Low or no speaker volume

Press the  key on the remote control to adjust the volume. **Aud 0** (off) to **Aud 4** (highest level).

Radar has short range

Set range (sensitivity) control to **SEn 4** (longest range). Note: Opposite/stationary direction mode and same direction mode sensitivity settings need to be set dependently. See page 18.

Radar suffers from patrol speed shadowing

If the patrol window indicates an incorrect patrol speed, the **PS BLANK** key blanks the patrol speed window and acquires a new patrol speed.. See *Patrol Speed Shadowing Effect*.

Press the **PS 5/20** key to change the low-end patrol speed from 5 mph to 20 mph, thus preventing a patrol speed lock below 20 mph. It is not possible to allow patrol speed locking less than 20 mph and to eliminate patrol speed shadowing simultaneously. Shadowing is eliminated when VSS is installed. See *Low-End Patrol Speed Selection*.

Radar will not lock onto patrol speeds below 20 mph

Press the **PS 5/20** key to change the low-end patrol speed from 20 mph to 5 mph. See *Low-End Patrol Speed Selection*. The radar will now be susceptible to patrol speed "shadowing," which can be corrected with the **PS BLANK** key.

Radar has trouble maintaining patrol speed

Mount the antenna higher above the dash and/or point antenna slightly down toward the ground. Make sure the wipers are not in the radar beam path. Make sure the windshield does not have paint/mask around the perimeter.

Radar picks up vehicle fan and reads 5 to 30 mph in stationary mode

Check for proper aiming of antenna. Make sure that the paint/mask or metallic objects are not deflecting the radar beam down into defroster vents. If so, raise antenna above obstruction. See *Fan Noise*.

Radar displays LO V icon

Make sure the cigarette-plug is securely installed and the contacts are clean.

Radar flashes Hot in display

The radar is overheating. Move radar out of direct sun. Do not leave radar operating in a closed vehicle.

Radar will not display readings below 10mph

Call Customer Service if this is desired.

STALKER DUAL MOUNTING OPTIONS

The *STALKER DUAL* radar system can be mounted many ways. As shown in the following drawings, Applied Concepts has designed unique mounting options for the *STALKER DUAL*. You can count on *STALKER DUAL* to give you the most flexible mounting options for your radar system!

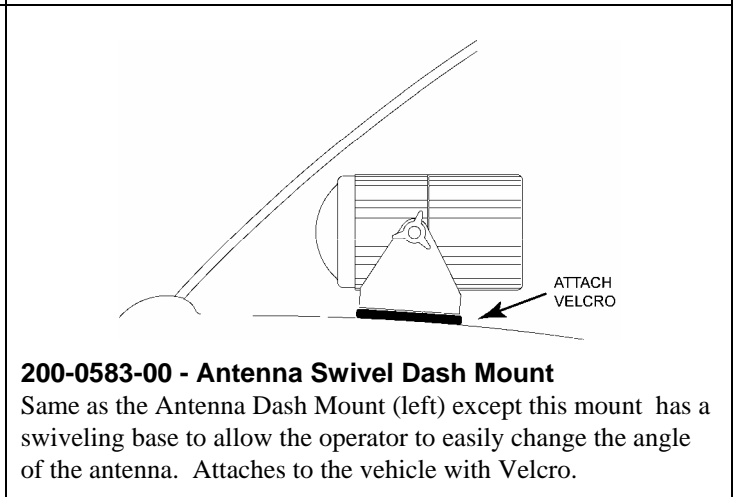
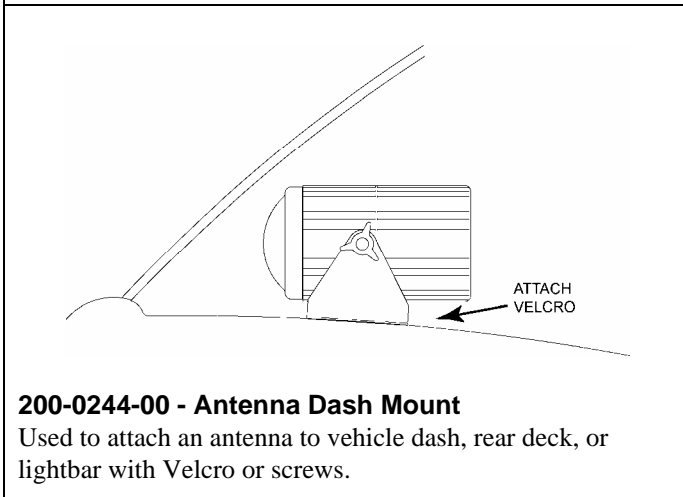
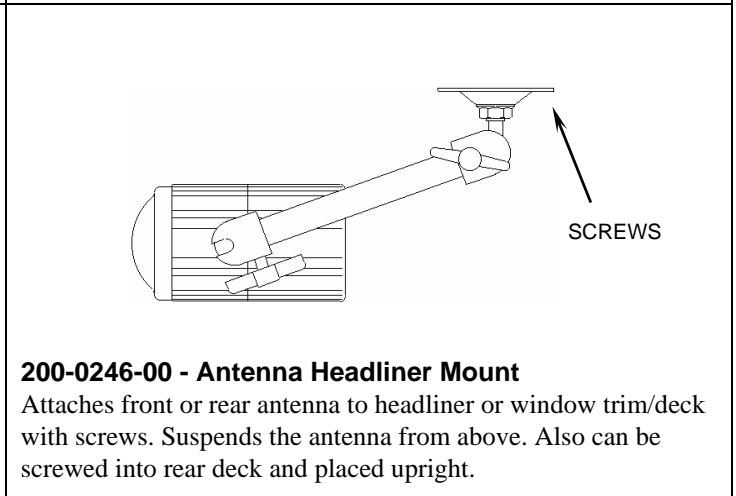
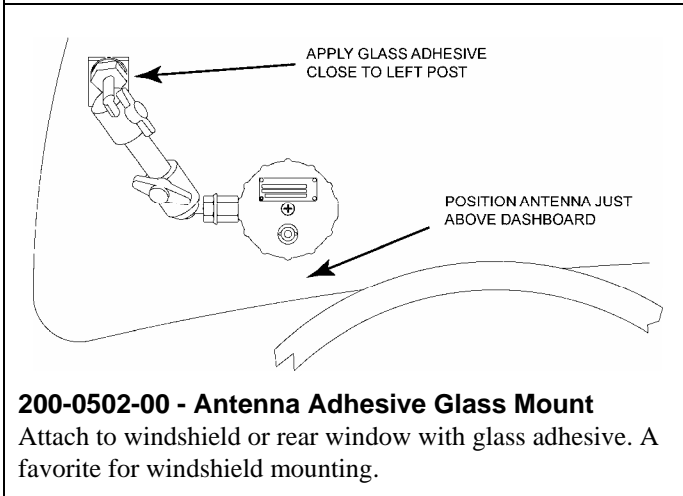
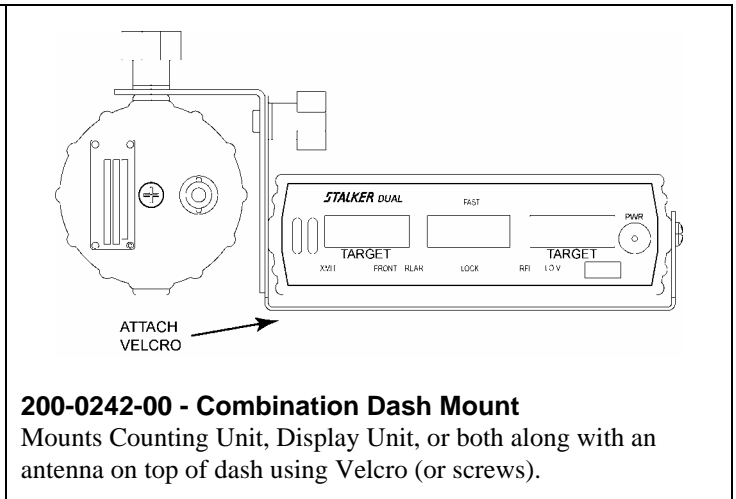
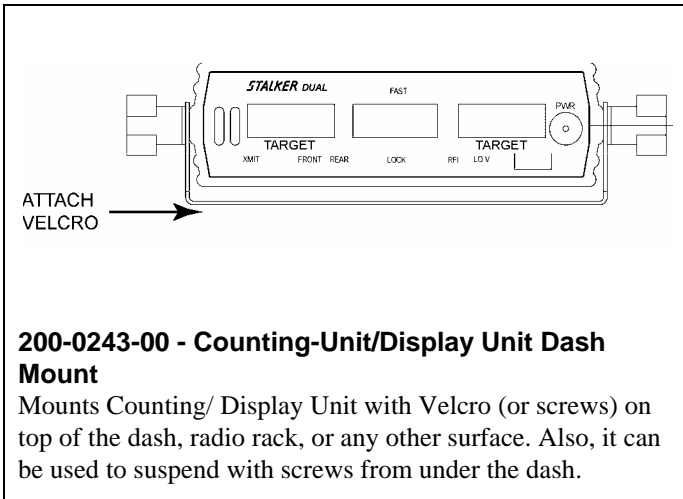

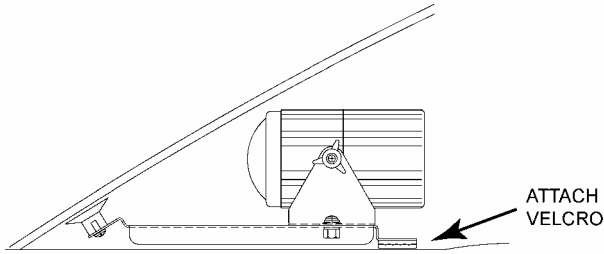

200-0262-00 - Antenna Mount, Dash w/suction cups
 Attaches antenna to dash with suction cups and Velcro. Allows 360 degree rotation.

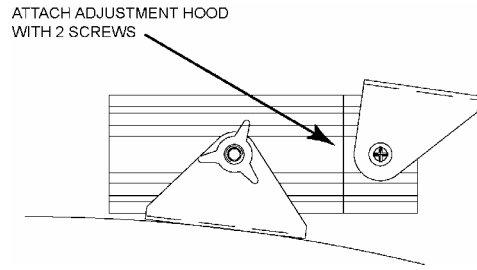

200-0252-00 - Display Hood Kit
 Attaches to display to shield the LEDs from direct sunlight during daylight operations. Also prevents LED reflections from appearing on the windshield during night operation. Only for non-switch display.

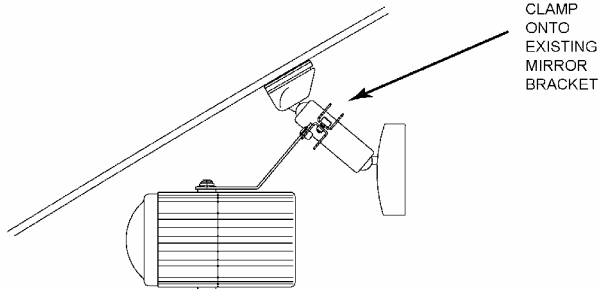

200-0259-00 - Antenna Mirror Clamp Mount
 Clamps on the existing rear view mirror bracket.

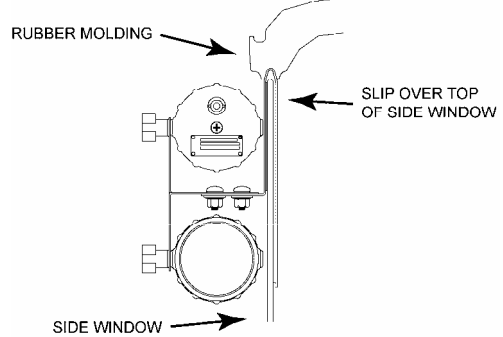

200-0504-00 - Antenna Side Window Mount
 Slips over top of side window glass and can mount either one or two antennas.

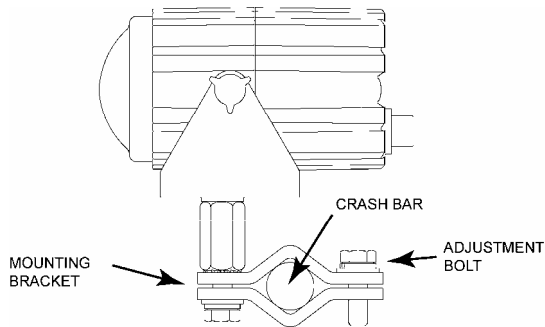

200-0525-00 - Antenna Mount
 Allows the antenna to be mounted to handlebars or crash bars from 3/4" to 1 1/2" in diameter.

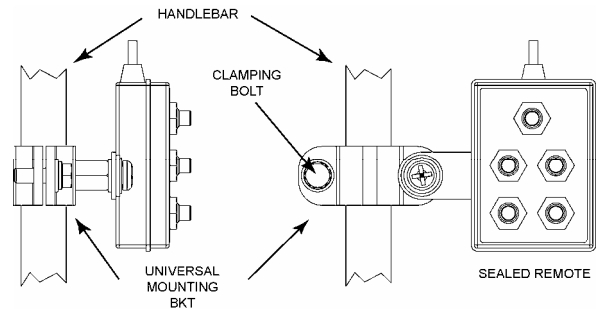

200-0279-00 - Sealed Remote
200-0524-00 Universal Mounting Bracket
 For mounting on handlebars from 3/4" to 1 1/2" in diameter.

STALKER DUAL OPTIONS

The **STALKER DUAL** offers several performance characteristics which can be formatted from the “menu setup.” Below are some of these features. If your radar does not have a feature listed below and you would like it incorporated, please contact Applied Concepts, Inc. at 1-800- **STALKER** or your Factory Sales Representative.

- **STALKER DUAL** can be interfaced with most In-Car Video systems, computers, printers, etc. The “menu” offers a variety of pre-programmed baud rates; 300, 600, 1200, 2400, 4800, 9600, 19200, and 38400.
- Message format can be selected for displaying on video systems, computer, printer, etc.
- Minimum Stationary speed display can be selected to start at either 2 mph or 12 mph. Factory setting is 12 mph.
- Various “locking” options can be selected. Normal Factory setting is both Target and Patrol. Speeds are locked with the Locked key depressed. Some states have other requirements. The unit is factory set for your state requirements. Choices are Lock only Target Speed; Lock neither Target nor Patrol Speeds, and Automatically Clears Lock within 15 minutes.
- The Harmonic Suppression indicator is a decimal point in the Target window. It lights up when double suppression is suppressing the target display. This is turned off in the normal factory setting.
- Faster Speed Tracking comes standard with all **STALKER DUALS**. This feature can be disabled if not desired.
- Audio loudness can be set for High or Low. All switch displays are set on High. All non-switch displays are set on Low.
- The **STALKER DUAL** can be set to be utilized as only a stationary radar.
- Selecting speed readings in miles or kilometers per hour is a menu selectable feature.
- Either one or two antenna operation can be selected. Factory setting is for two antennae unless specified on the order. This allows for easy upgrade to a dual antenna.
- For Michigan customers, there is a special sensitivity (range) setting: the radar allows settings of 0 through 4 instead of the normal 1 through 4 selections.

Other menu selections are preset at the factory. We encourage all menu selections to be done by the factory, by factory authorized service centers, or factory sales agents.

WARRANTY

Manufacturer warrants this traffic speed radar to the original purchaser to be free of defects. At its discretion, the manufacturer agrees to repair or replace all radar components that fail due to defective materials or workmanship for a period of three (3) years from the date of purchase.

During the warranty period, there will be no charge for repair labor or parts. Purchaser shall return the failed unit to the factory or authorized service center, freight prepaid. The manufacturer will pay return shipping.

This warranty applies only to internal electronic components and circuitry. Warranty excludes normal wear-and-tear such as frayed cords, broken connectors, scratched or broken cases, or physical abuse. Manufacturer reserves the right to charge for defects and/or damages resulting from abuse or extraordinary environmental damage to the unit during the warranty period at rates normally charged for repairing such units not covered under warranty.

Seller warrants the radar devices manufactured by Applied Concepts, Inc. are designed to perform the function of determining the speed of motor vehicles. The foregoing warranty is exclusive, in lieu of all other warranties, of quality, fitness, or merchantability, whether written, oral, or implied.

As a further limit on warranty, and as an expressed warning, the user should be aware that harmful personal contact may be made with seller's radar devices in the event of violent maneuvers, collisions, or other circumstances, even though said radar devices are installed and used according to instructions. Applied Concepts, Inc. specifically disclaims any liability for injury caused by the radar devices in all such circumstances.

Note: We have several Factory Authorized Service Centers located throughout the country. For the Service Center nearest you, call the factory at 1-800-**STALKER** (1-800-782-5537).